

DECO[®] | LIGHTING

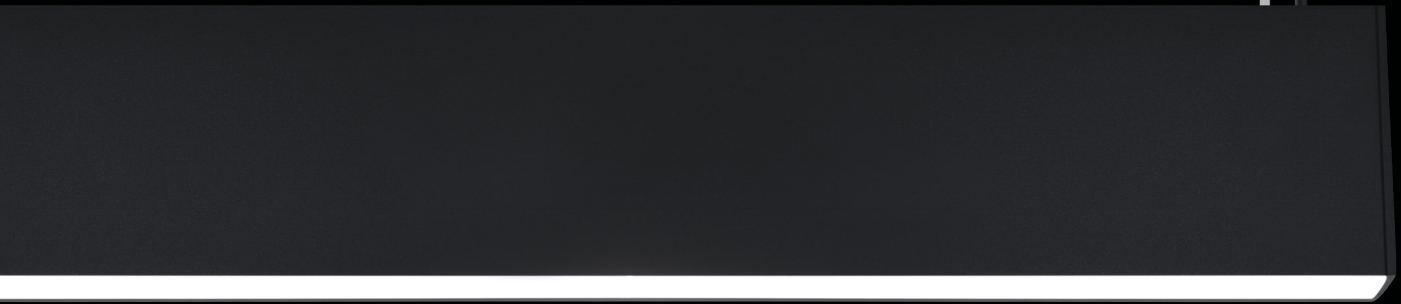

VECTOR[™]
Architectural LED Luminaire



Welcome to VECTOR™

The Vector Luminaire Series is a specification grade product designed and produced in Los Angeles, California.

Built to the highest standards, Vector is capable of incorporating 5-channel color tuning using wireless or DMX controls. A recipient of the distinguished PIA Architectural Awards and recognized by the Illuminating Engineering Society (IES) Progress Report of 2017, the Vector Luminaire Series boasts the highest efficacy of its category in the industry, while maintaining high CRI and a 2 Macadam Ellipse color consistency over its lifetime.



A handwritten signature in black ink that reads "Sam Sinai".

Sam Sinai
CEO & Founder



Redefining Luminaires

While the Vector is a high performance luminaire, featuring top-end performance paired with a modern aesthetic, the true ingenuity comes from its convenient modular construction. Designed from the ground up to be a series of building blocks, the Vector becomes a system of endless possibilities allowing lighting designers to envision their designs without limitation.



Table of Contents

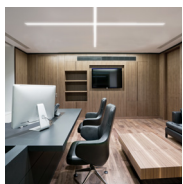

Welcome	02
Made In USA	07
Flexibility	09
Aperture Size	11
Versatility	13



Patterns	15
5 Channel Color Tuning	17
Outstanding Presentation	19
Light Control	21
Custom Color Options	23

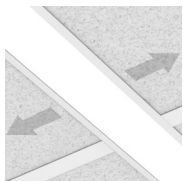

10 Year Warranty	25
Adjustable Design	27
Smart Control	29
Elegant	31
Functional Style	33



Continuous Run	35
Vector Pendant	37
Vector Wall Mount	41
Vector Surface Mount	45
Recessed Flanged	49



Recessed Flangeless	53
Recessed T-Bar	57
Mud in Flange	61
Predefined Configurations: Cube	65
Predefined Configurations: Hex	67

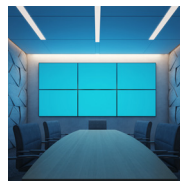

Predefined Configurations: Triad	69
Photometrics	71
Lumen Chart	73
Quickship Models	75
Ordering Information	77



VECTOR



CALIFORNIA
-MANUFACTURING

Made in USA

Located in the heart of Los Angeles, California, the Vector is a Made in the U.S.A. luminaire. Each Vector is constructed from the ground up with true American grit and unmatched durability. Domestic manufacturing allows us to deliver top-quality fixtures, ensuring quality workmanship from a manufacturing team that truly cares about the product it's building. The ability to deliver a better product with faster manufacturing and shipping times, makes all the difference.

DECO[®] | LIGHTING



Flexibility

The Vector series of luminaires and accessories delivers an infinite toolbox for specifiers, architects, and lighting designers to utilize. Featuring a variety of finishes, color temperatures, aperture sizes, lengths, and control solutions, the Vector can be deployed in an endless number of arrangements to create a truly unique space.

Color Options



2700K



3000K



3500K

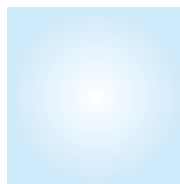

4000K



RGBWW

Mounting

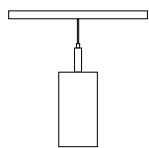

pendent

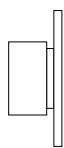

wall mount

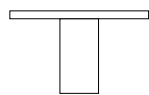

surface mount

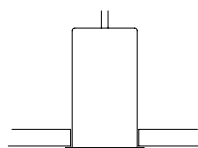

recessed flanged

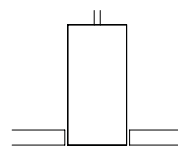

recessed flangeless

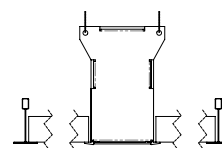

recessed t-bar

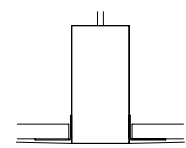

mud in flange

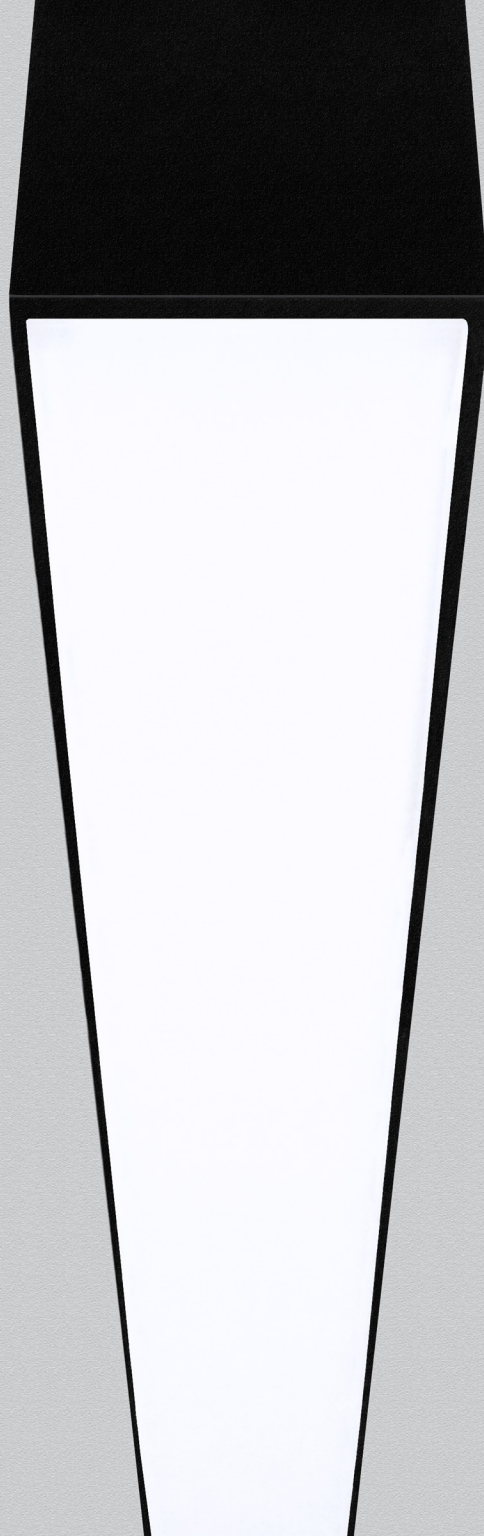



Vector 1 (V1)



Vector 2 (V2)



Vector 3 (V3)

Aperture Sizes

The Vector family of luminaires is currently available in three aperture sizes, enabling designers to match the desired aesthetic for an interior space. All apertures are available in standard lengths of 2ft, 3ft, 4ft, 6ft, and 8ft; the luminaires can also be joined together to create continuous runs of infinite length in one-foot increments.

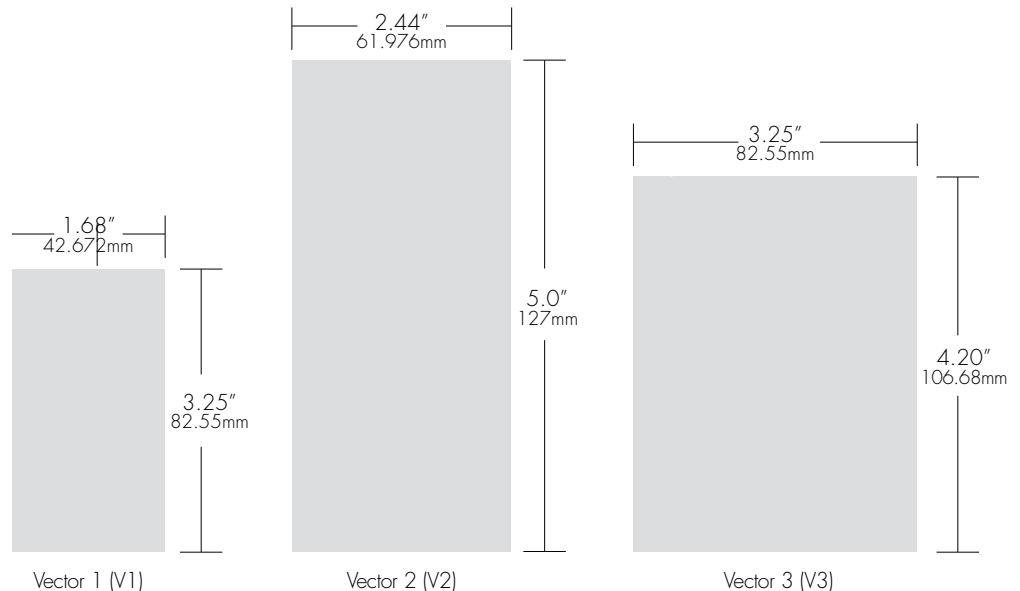

Versatility

Available with several lit joiner accessories, the Vector linear series can transform into any variety of shapes to execute unique interior designs, from simple to complex. The Cross, Lit Corner, Tee, and Wall-to-Ceiling standard accessories enable the luminaire series to become an active element in the desired aesthetic of a space.

Accessories

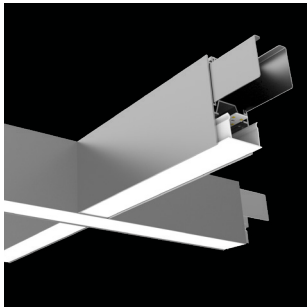

cross

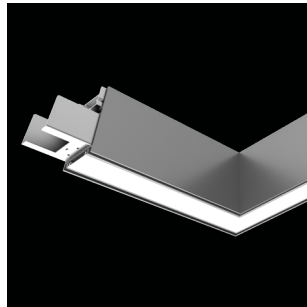

lit corner

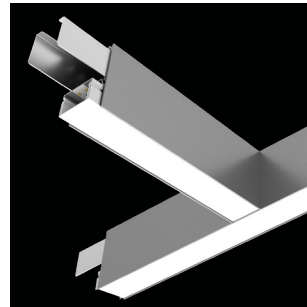

tee

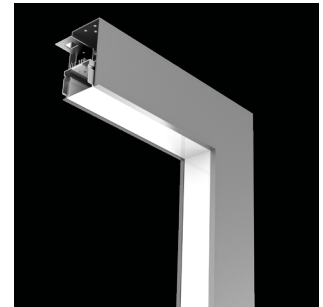

wall to ceiling





Patterns

In addition to the standard shapes available on the Vector, the variety of joiner accessories provides designers with a blank canvas to create any number of unique fixture layouts.

From simple to complex designs, the Vector can transform into asymmetric crosses, interweaving squares, or even three-dimensional runs utilizing the wall-to-ceiling accessory. Imagine the possibilities.

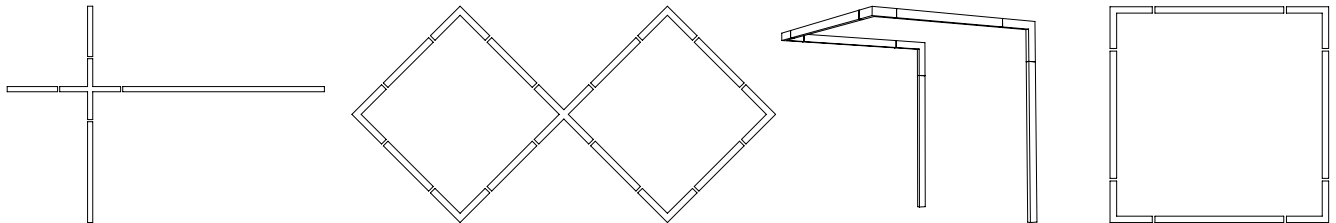

5 Channel Color Tuning

The number of control channels deployed in a color tuning system impacts the quality of the light and consistency of color. It also affects the color tuning range, the level of gamut control and the efficacy of the solution.

Deco Spectrum™ mixes five different colors of high brightness, broad spectrum LEDs – none of which are white – to deliver light that is 2 MacAdam ellipses about the Planckian curve at 90+ CRI across the tuning range. The result: light that accurately depicts – across the full tuning range – the object's color as compared to its color in true sunlight.

Benefits:

- Perfectly natural white light.
- On-Planckian tuning from 1650K to 8000K.
- Dimming from 100% to 1% while maintaining CCT, or variable CCT from 3050K down to 1800K to match traditional incandescent or MR-16 lamp dimming
- Industry-leading color rendering (Ra) greater than 90, throughout the tuning range.
- Gamut control for unlimited control and customization of lighting design using the Saturation and Hue controls.
- Consistent color of 2 SDCM about the Planckian Curve over the life of the module.

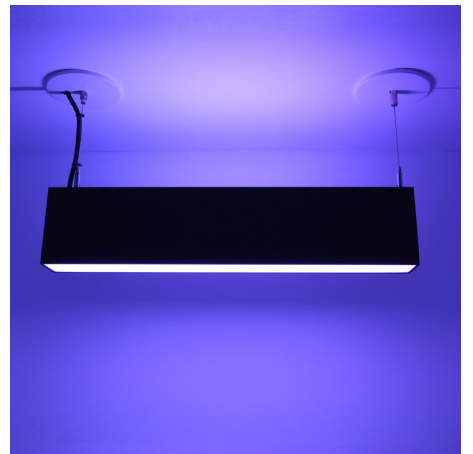
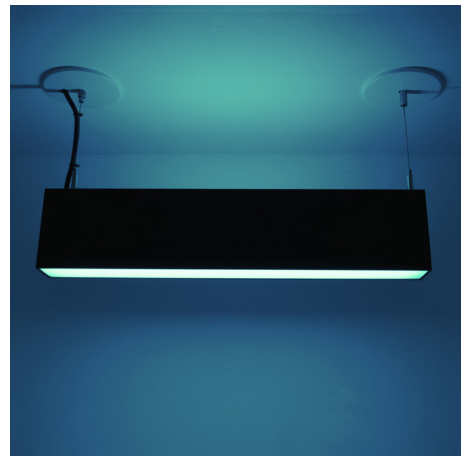
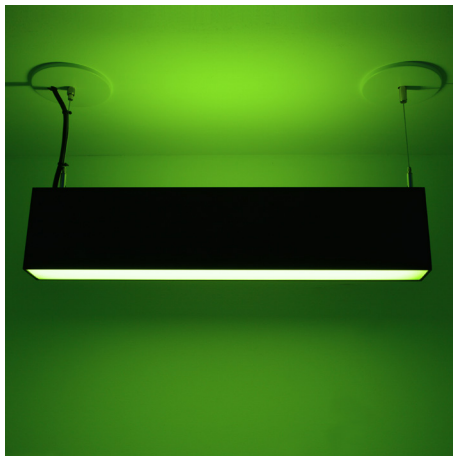
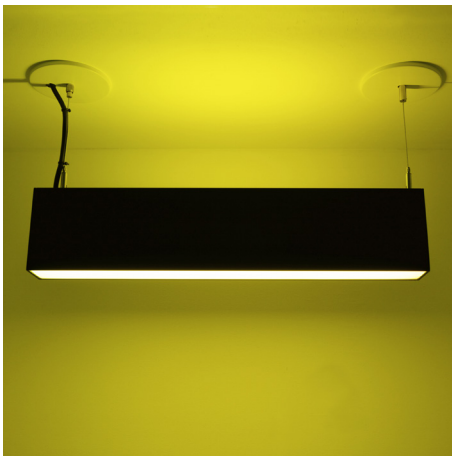

Outstanding Presentation

The Vector signals a step forward in ambient interior illumination, merging sleek design with energy-efficient performance. Aiming to reduce energy consumption and provide top-quality light output, the Vector performs at up to 109 lumens per watt and delivers accurate color rendering for interior spaces, featuring 95 CRI minimum with an R9 value of 69 or greater. The Vector enables designers to create comfortable, uniformly-lit spaces while using 50% less energy compared to traditional fluorescent systems.

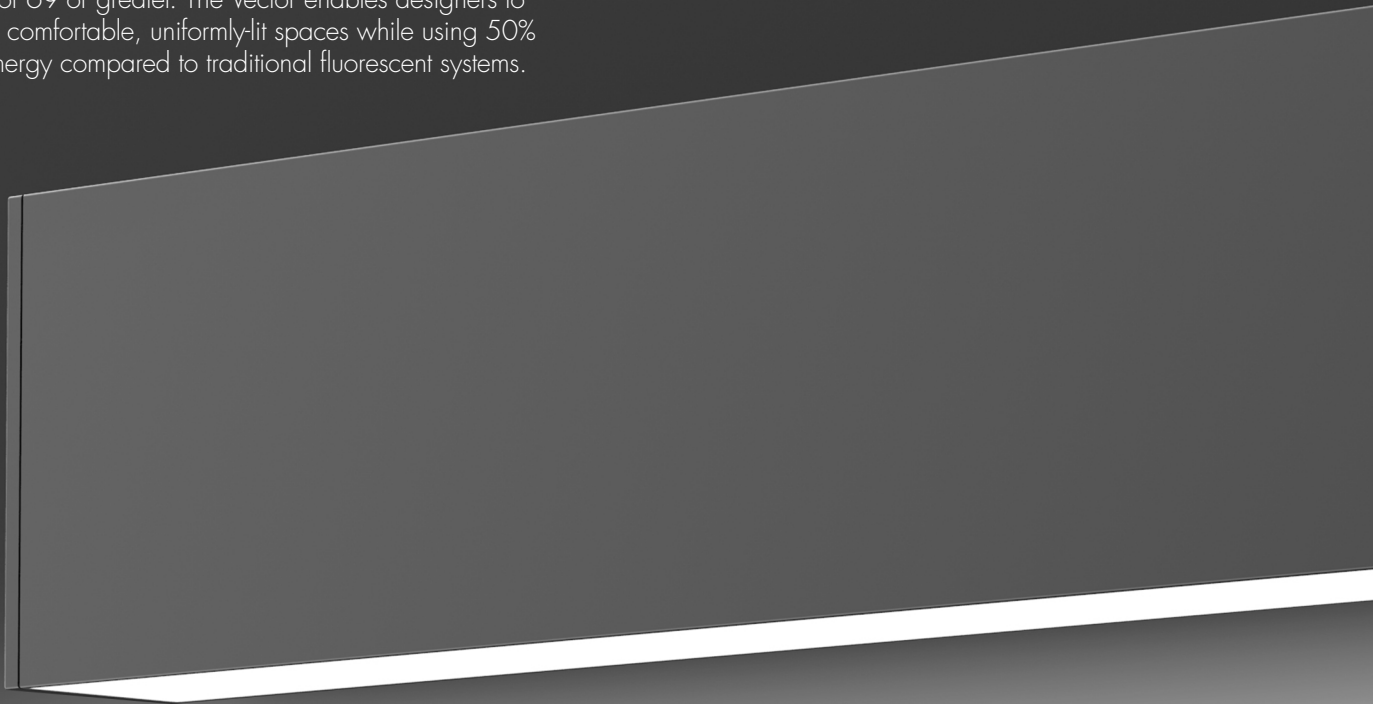



1,400 lm/ft indirect

1,200 lm/ft direct

CRI of 95 min with R9 of 69 or better,
and ETL approved for dry and damp locations

Operating Temperature: -30°C to +55°C (-22°F to +131°F)

Indirect (Up) Output

Output Selection	Low	Medium	High
Nominal Wattage	7.5W/ft	10W/ft	15W/ft
Lumens Per Foot	720	1080	1440

Direct (Down) Output

Output Selection	Low	Medium	High
Nominal Wattage	7.5W/ft	10W/ft	15W/ft
Lumens Per Foot	570	850	1160

Light Control

No modern lighting system is complete without proper lighting controls. The Vector has been designed to integrate with nearly any lighting controls system. Implementing lighting controls will deliver increased versatility and energy savings to an application, further benefiting the customer and the efficiency of the interior space. The Vector integrated with next-generation lighting controls turns the fixture into a robust digital luminaire, bringing together the benefits of both form and functionality.



Direct

Direct illumination delivers light to task areas, where proper distribution can boost the energy levels and alertness of occupants.



Direct/Indirect

A mix of direct and indirect illumination adds flair to interior environments, making spaces feel larger and more open.



5-Channel Color Tuning

Implementing quality color tuning technology can have a variety of applications, from complementing the schedules of inhabitants to providing unique themes and identity to spaces.



Dimming Capability

The Vector features dimming standard down to 10%, and optional down to 1%. Full dimming control allows spaces to adapt to meet the needs of various activities, from lively meetings to intimate presentations and more.

A-Classic Series

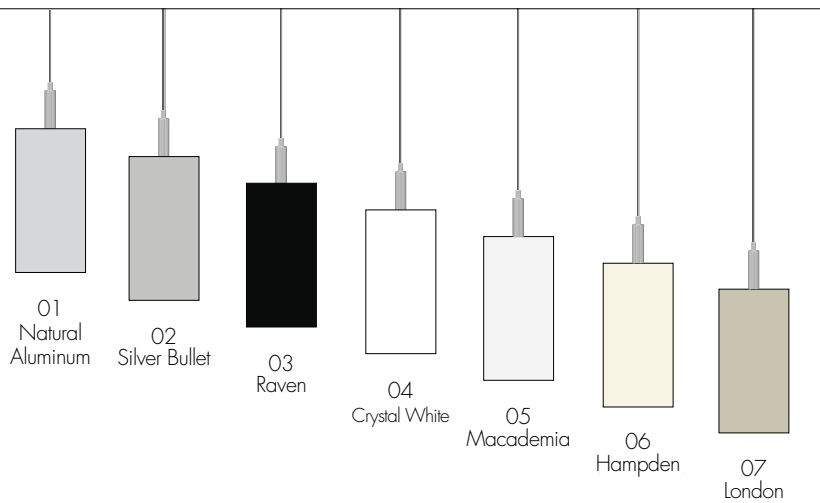

B-Urban Series

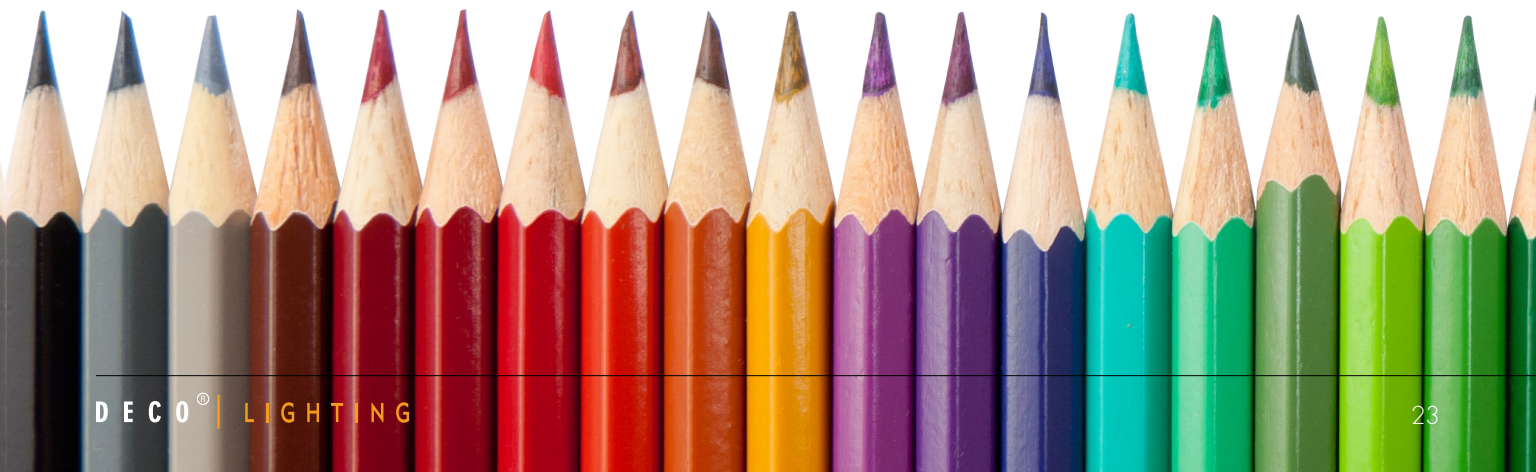
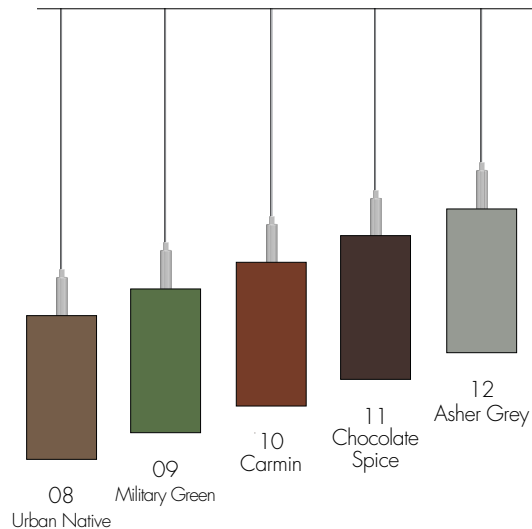

Custom Color Options

The Vector features a unique set of 24 special paint finishes. These standardized colors enable designers to match the Vector to the aesthetic of a space without having to worry about the extended lead times associated with “custom” finishes. This preset palette of 24 finishes adds only marginal lead time and cost over a standard Vector luminaire.

C-Fresh Series

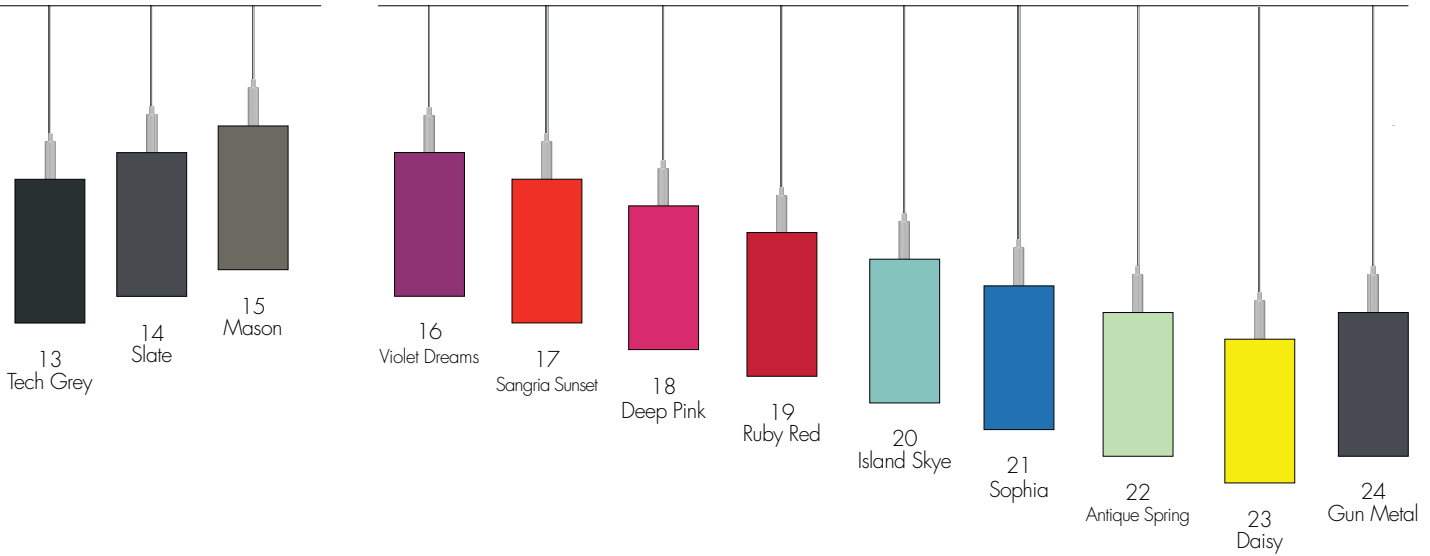

10 Year Warranty

Deco Lighting's industry-leading 10-Year, 100,000-hour warranty evolved from our team's drive to design, engineer, and manufacture top-quality LED lighting systems in the United States. From the initial sourcing of resilient fixture materials and high-performance LED chipsets to the attention to detail we provide during assembly and packaging, this complete start-to-finish assurance process is what gives us the confidence to back all of our LED luminaires with this unbeatable warranty.



Durable Fixtures

Vector luminaires are constructed with sturdy housings built using extruded and precision-formed acrylic diffuser lenses. An efficient and functional design within the housing creates a massive surface area for efficient thermal dissipation to reduce operating temperature and further extend fixture life.



Labor Included

In addition to covering the entire fixture, including the LED driver, our warranty includes a labor allowance should any issue arise within the warranty period that requires labor to be performed during the correction or replacement process.



Lumen Maintenance

The extended lifetime delivered by under-driving the industry's finest LEDs offers several benefits over the traditional fluorescent systems, from eliminating the cost of bulb replacement to the advantage of using a product that depreciates less than 7% over the course of 10 years.

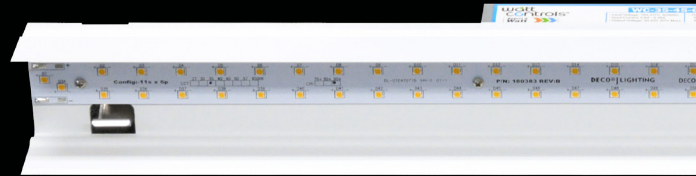



LED

State-of-the-art LED chipsets deliver unparalleled lighting performance and give the Vector an L70 rating of 159,000 hours. This translates to an operational lifetime of over 15 years if operated at a full 24 hours per day!



Cooltech

By under-driving our LEDs we reduce fixture temperature and extend LED life considerably. In fact, our patented Cooltech boards lead to a faster heat transfer rate and lowers heat buildup (up to a 20° C reduction) compared to the traditional LED board systems used by our competitors.



Driver

The LED driver system yields superior performance compared to other third-party driver systems, rated to operate in a temperature range of -40°C to +95°C & delivering a power factor of 0.95 or greater along with low harmonic distortion.

These six key elements, combined with our dedication to constantly innovate and develop next-generation lighting solutions, come together to deliver a winning formula when selecting Vector products. In essence, we put our money where our mouth is and provide our clients the confidence to specify our innovative lighting systems across a variety of applications.

Adjustable Design

The Vector series of linear architectural luminaires help achieve perfectly positioned lighting layouts that are easily specified. The precision-engineered design allows for just the right amount of light, providing cost savings and energy efficiency.

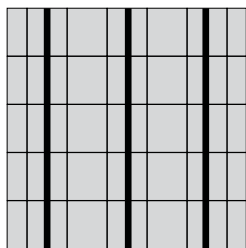

Continuous Run

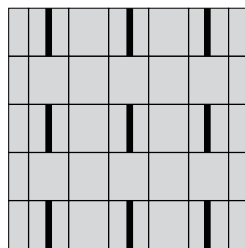

Non-Continuous Run

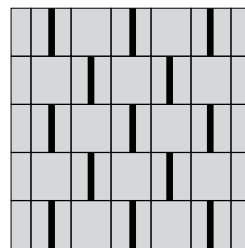

Asymmetric Non-Continuous Run

— = vector

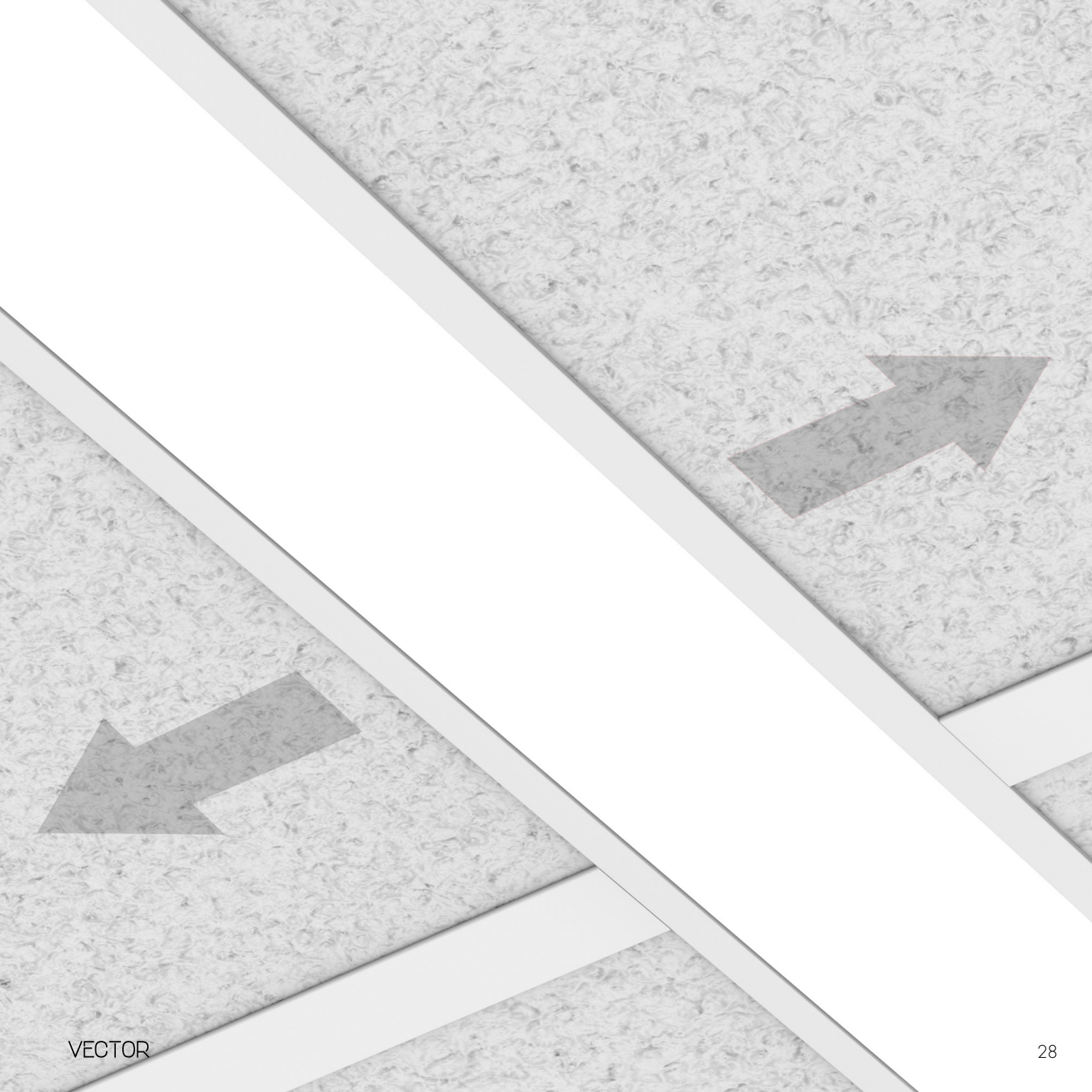

Smart Control

The Vector is compatible with a variety of advanced sensor solutions from Phillips, Lutron, Enlighted, and Osram, to name just a few. Smart sensors are an ideal add-on for those seeking additional functional benefits and even deeper energy savings over traditional fluorescent systems. Smart sensors increase the versatility of the Vector, transforming the way in which the luminaire adapts to the needs and behaviors of inhabitants within a space to create a smart building solution that marries design with function.

Smart Sensors	Protocol	Compatible Networks*	Occupancy	Daylight	Temperature Reporting	Communication to Luminaire
 DECOMESH	BLF Blue Tooth Low Energy	DECOMesh	Enabled	Enabled	No	Wired
 nLIGHT	nLight	nLight	Enabled	Enabled	No	Wired
 enlighted	Enlighted RF	Enlighted RF	Integrated	Integrated	Yes	Wireless
 legrand® WATTSTOPPER®	DLM	DLM	Enabled	Enabled	No	Wired
 LUTRON.	EcoSystem	Quantum, Energi Savr Node, Energi TriPak	Enabled	Enabled	No	Wired
 VIVE	Lutron Clear Connect®	Lutron Vive System Network	Enabled	Enabled	No	Wireless
 OSRAM	ZigBee HA	Osram ENCELIUM & Simplex, Daintree Networks	Enabled	Enabled	No	Wireless
 PHILIPS	ZigBee HA	Philips	Enabled	Enabled	No	Wired

*Not all compatible networks may be listed.



DECO MESH

Utilizing Bluetooth Smart® technology, light fixtures interact directly with smartphones, without the need of a bridge or complex setup. Luminaires can be operated in public mode, giving access to everyone, or private mode, restricting access to select individuals.

nLIGHT

nLight® is a networked digital lighting control solution that delivers energy savings and increased user configurability by combining time-based, daylight-based, sensor-based and manual lighting control schemes.

PHILIPS

Phillips sensor solutions are designed for applications that include retail and hospitality, office spaces, public areas, and education. Offering devices that combine motion detection, light level assessment, and dimming into single units, Phillips delivers a system for sophisticated yet simple lighting control.

enlighted

Patented, software-defined smart sensor solution that tracks real-time occupancy, light levels, ambient temperature and energy usage, along with other data points. Enlighted sensors can distinguish between people and objects, customize controls for specific tasks, leverage ambient light provide unmatched coverage for data collection.

VECTOR™

LUTRON®

Utilizing the proprietary EcoSystem® communications protocol, Lutron provides a two-way digital network that incorporates motion sensing, daylight harvesting, occupancy/vacancy sensing, and high performance dimming functionality.

vive

A modular wireless lighting control system utilizing Lutron-patented and proven RF protocols designed for new and existing buildings. Vive System wireless solutions are well-suited for K-12 schools, commercial and government offices, and university campuses where the customer is looking to meet basic code requirements while enabling simple commissioning, operation & reporting via IoT capable smart devices.

legrand® WATTSTOPPER®

Wattstopper offers a comprehensive line of simple, scalable and flexible energy efficient lighting controls and solutions for commercial and residential spaces with a mix of digital lighting management built on occupancy, plug load, and daylighting controls.

OSRAM

The OSRAM Connected Lighting Module (CLM) enables luminaires to be connected to any lighting management system utilizing the ZigBee® Home Automation communication protocol. The CLM allows each luminaire to adapt to the needs of a facility, featuring multi-zone daylight harvesting, precision dimming, and occupancy sensing.

Elegant

The Vector's sleek profile is designed to blend into clean, minimalist architectural spaces featuring simple yet powerful lines – a modern luminaire free of unsightly lamp shadowing and unevenness associated with fluorescent fixtures.

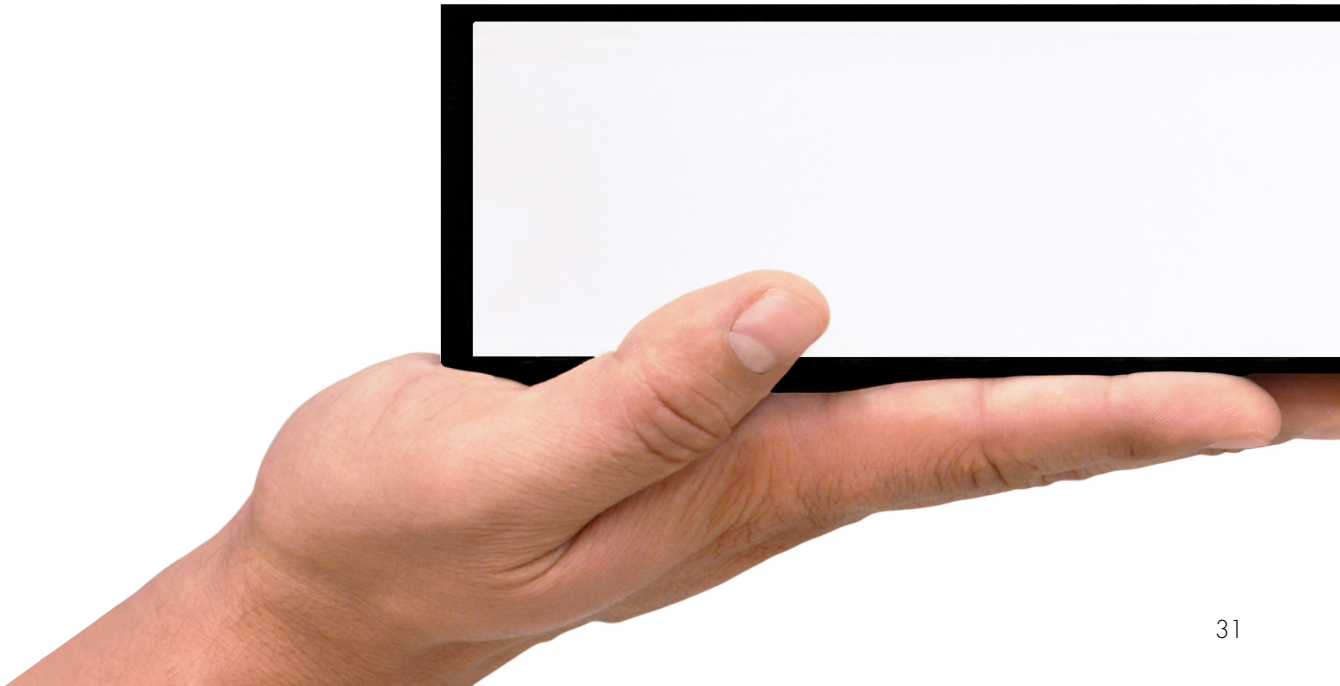

Sleek profile

Vector 1: 1.68" (42.67mm) wide • Vector 2: 2.44" (61.97mm) wide • Vector 3: 3.25" (82.55mm) wide



Clip-in Tray

Allows light engine to be conveniently installed after luminaire body has been mounted.

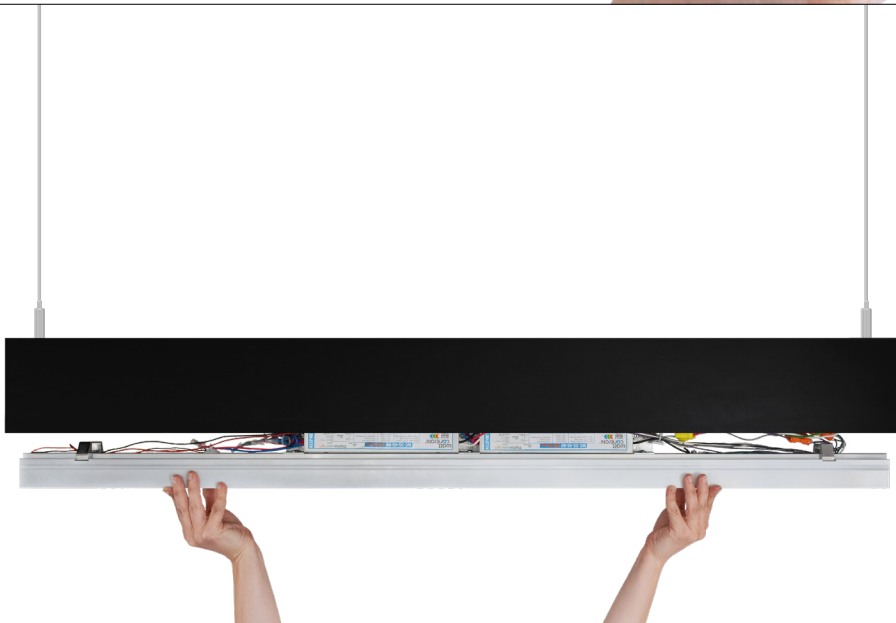

Utilitarian Construction

Makes luminaire upgrades & field servicing a simple process.

Functional Style

Built on the core of its modern, practical design philosophy, the Vector system allows easy access to critical components to simplify installation or in the event that repair or replacement becomes necessary.



Snap-in Lens Detail

Easily installs after light tray has been clipped into luminaire body.

The Vector Series as a Kit of Parts

Deco's revolutionary design makes it super easy to assemble runs of any length. Our Continuous Run Guide, available as a pdf on our website, eliminates the guesswork, ensuring confidence that you will get exactly what you need for your specific application.

The Vector breaks each run into the following simple segments:

First of Run: a first segment has two mounting points, a power feed, and one end cap.

Middle of Run: a middle segment has one mounting point, no end caps, and the power is fed from the previous segment.

End of Run: an end segment has one mounting point, an end cap, and the power is fed from the previous segment.

Runs are created by using 8 foot or 6 foot segments at the beginning of the run, and then shorter segments are used to make up the run length.

Top View

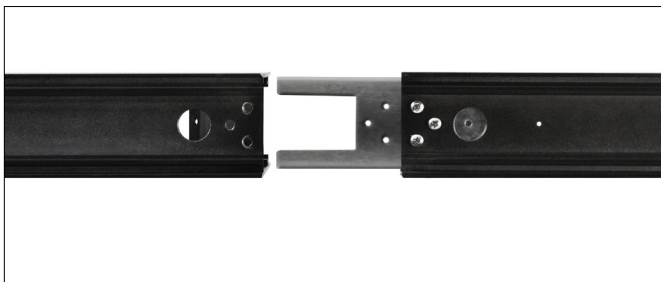

Step 1: Screw aligner into one housing then slide aligner into adjoining housing



Step 2: Do not screw aligner into the adjoining housing

Continuous Run

Featuring versatile mounting options and standard sizes, Vector can be configured in one foot increments using four types of standardized luminaire segments. Runs are created by using standardized 8 or 6 foot segments at the beginning of the run, and shorter segments to make up the entire run length.

Bottom View

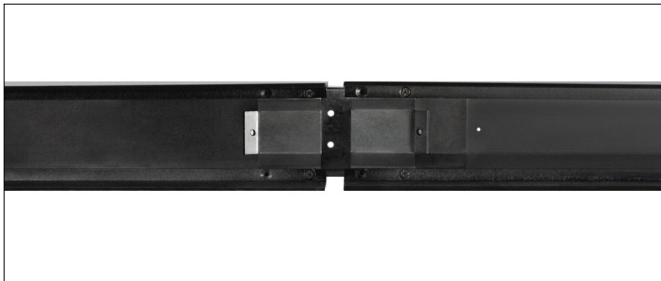

Step 3: Screw pull key into the pull bases located at the ends of the adjoining housings

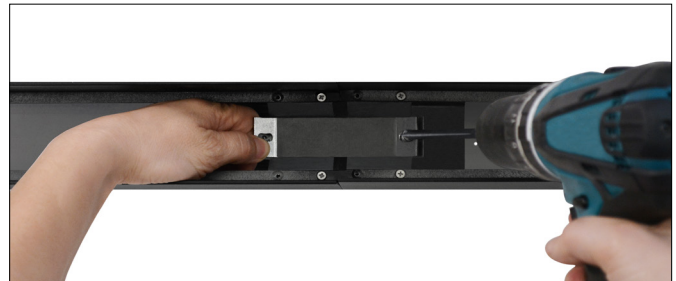

Step 4: Incrementally tighten both screws on the pull key until the housings are pulled together snug, ensuring the run remains level and true. Do not overtighten screws



Step 5: Connect power & dimming wire connectors before snapping trays back into place

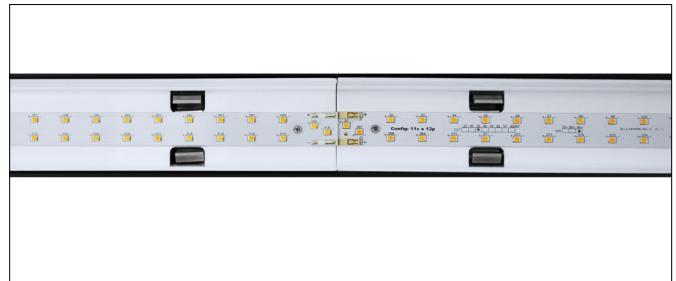

Step 6: Ensure that wires are not pinched by light trays



VECTOR™ Pendant

The Vector Pendant is a 2 7/16" linear architectural luminaire with a discreet profile. Standardized luminaires are provided in nominal lengths to deliver balanced, full, illumination. Available in lengths of 2', 3', 4', 6', and 8', and can be joined together in seamless runs of any length in 1 foot increments.

Equipped with the standard mounting aircraft cable of 1/16", the fixture is easily adjustable in height and position. The aircraft cable slides along the length of the Vector's housing, allowing for mounting flexibility.

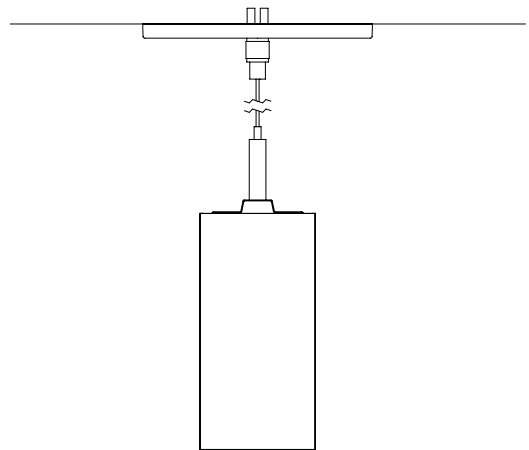





Step 1: Secure cross brackets to junction boxes for both power and non power mounting points.



Step 2: Secure canopy with power canopy coupler (Power Feed Mount) & secure canopy with cable terminal (Non Power Feed Mount).



Step 3: Feed aircraft cable into cable grippers, adjust height and level luminaire.

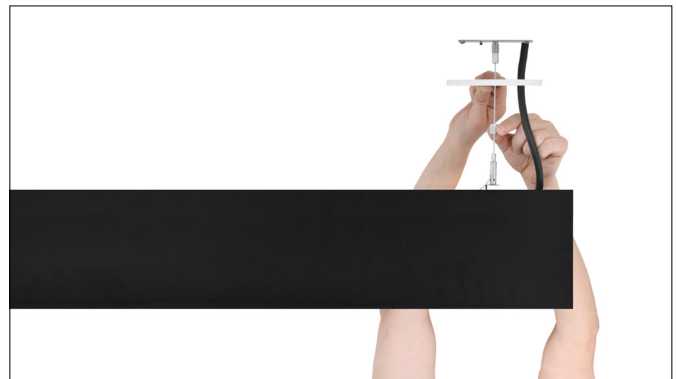

Step 4: Unscrew outer coupler to allow access to junction box. Feed power cord through canopy.

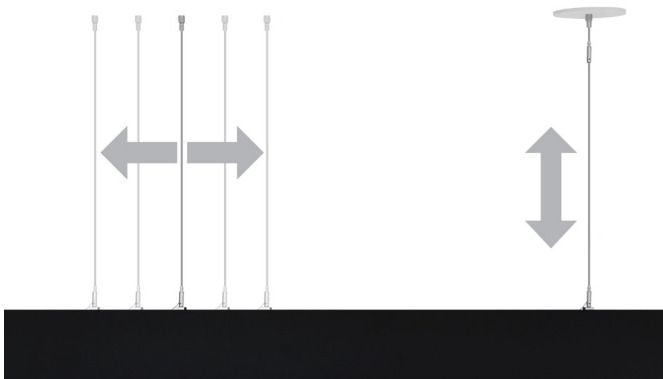

Pendant Installation

A simple design and adjustable components provide a flexible and hassle-free experience when installing the Vector Pendant.

Adjustable Mounting Points

Provide installation flexibility, working around air ducts or ceiling obstructions.

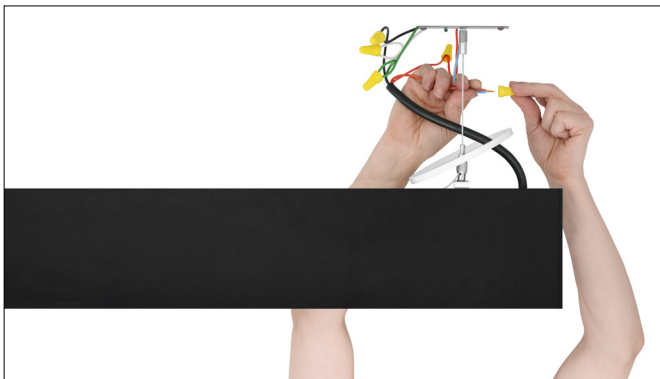

Step 5: Secure canopy back in place with outer coupler.



Step 6: Snap strain relief around power cord. Press into canopy.

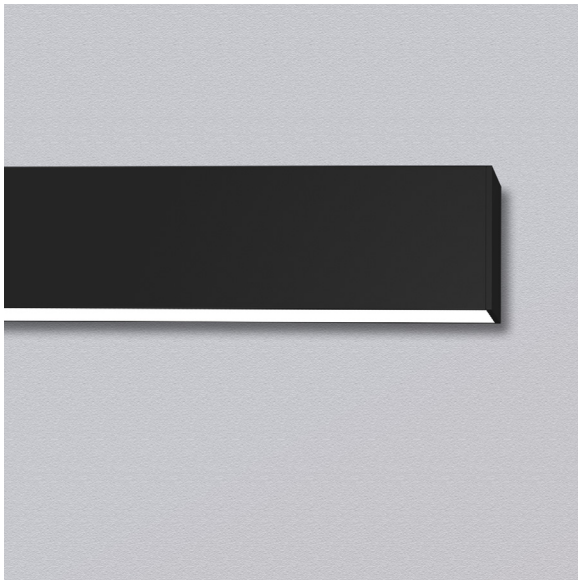

VECTOR™ Wall Mount

The Vector Wall Mount Direct/Indirect is available in a surface reverted design, with a sleek low-profile sensibility optimal for architectural lighting applications. The two-part wall mount bracket allows for easy installation, and a discreet architecturally-pleasing aesthetic.

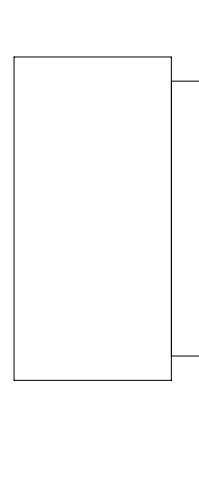

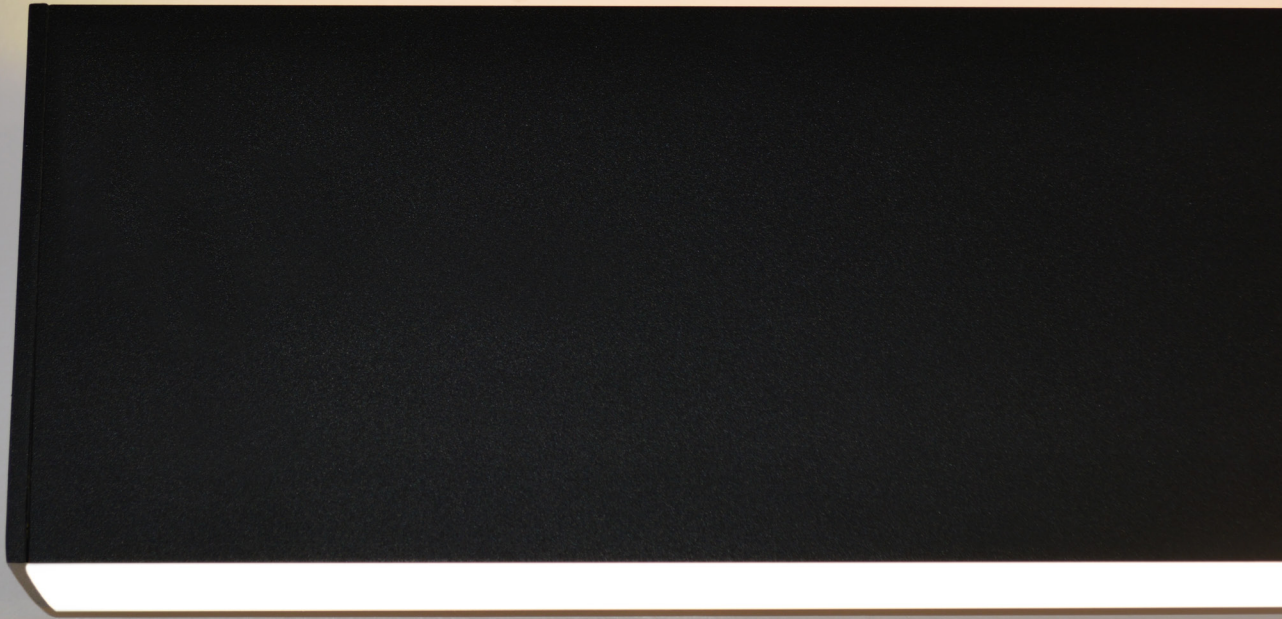



Step 1: Install wall bracket onto wall using the appropriate mounting hardware (not provided). Wall mount brackets can be mounted directly to studs, using appropriate anchors, an octagonal junction box, or a 2x4 single gang switch box.

Step 2: Make electrical connections as per local and national electrical codes. Push wires into the junction box behind the bracket.

Wall Mount Installation

The wall mount variant of the Vector incorporates an easy-to-use, two-piece bracket system which enables a single user to install the luminaire in minutes.



Step 3: Hook luminaire bracket over the wall bracket.



Step 4: Once in place, tighten screws through the underside of luminaire bracket into the threaded holes on wall bracket.

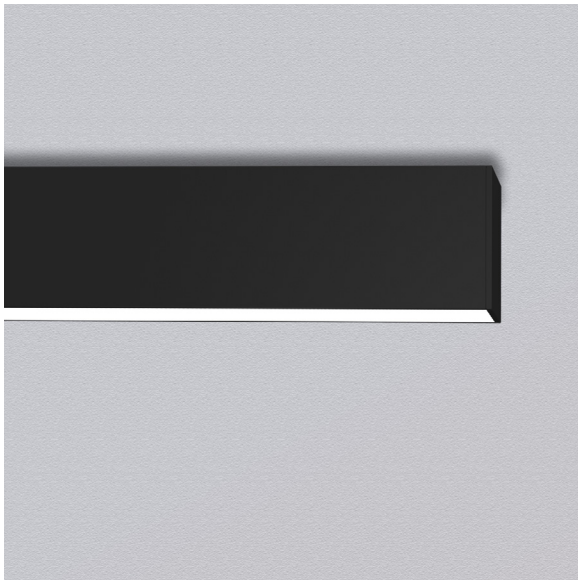

VECTOR™ Surface Mount

The surface mount Vector is attractive and easy to install with simple screws or threaded studs which pass through the housing to fasten the luminaire in place. The surface mount detail enables designers to mount the luminaire on walls and ceilings to enhance architectural styling or add a unique flair to the interior design of a space.

Ideal for locations with low ceilings or where fire ratings prevent recessed luminaires, the surface mount Vector can be installed as individual luminaires or in continuous runs.

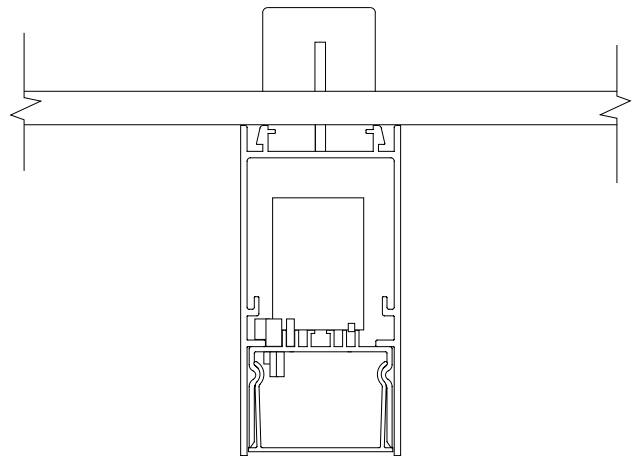





Step 1: Remove lens.



Step 2: Remove tray.



Step 3: Secure housing to ceiling.

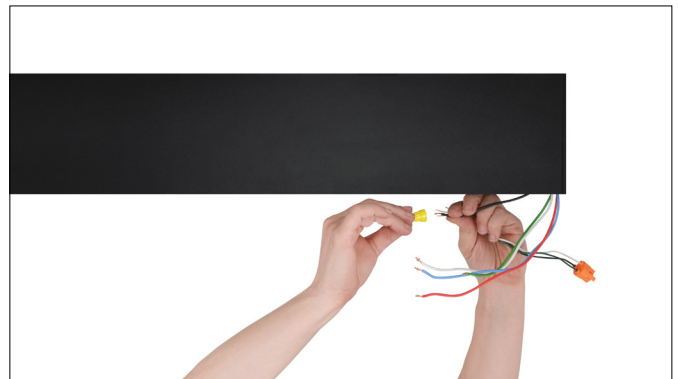

Step 4: Connect hot, neutral, ground and dimming to quick disconnect pigtails.

Surface Mount Installation

The surface mount Vector installs quickly and easily,
and provides a clean, understated installation.



Step 5: Connect tray to power.



Step 6: Snap tray in place; Snap lens in place.

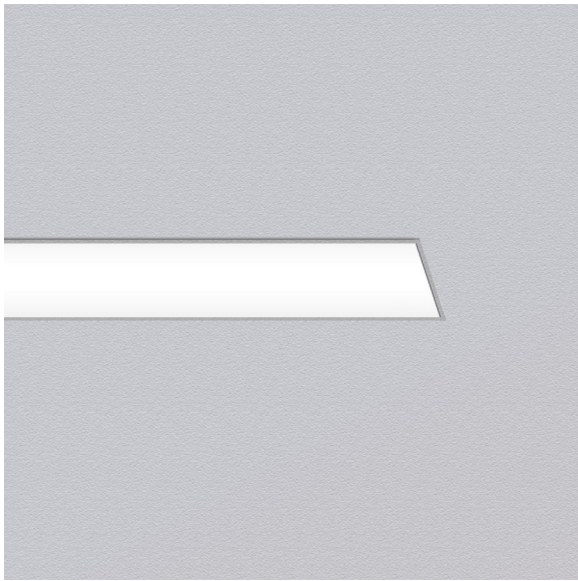

VECTOR™ Recessed Flanged

The recessed Vector is available with a slim, elegant flange designed to mask any openings or uneven edges in drywall cutouts and ensure a professional, uniform look once installed. Vector recessed flanged luminaires can be mounted using threaded rods, fasteners, or the Vector slip-through bracket detail.

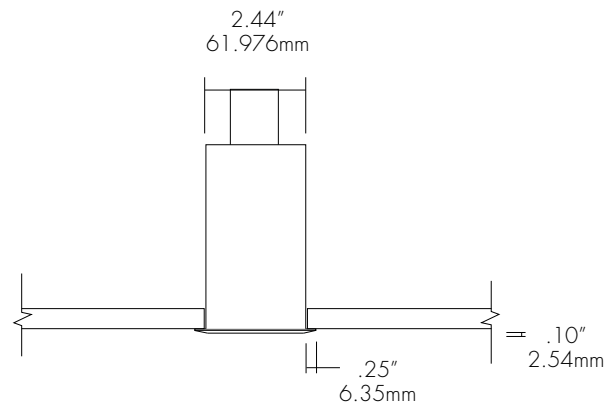



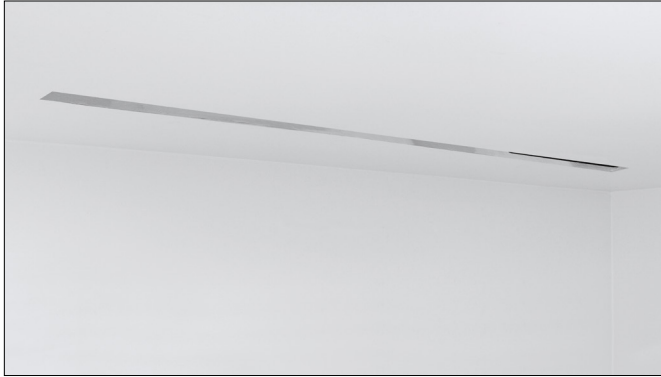

Step 1: Turn off power to the circuit. Prepare opening in the ceiling for the luminaire.



Step 2: Remove knockout plate and connect flex to knockout plate. Reinstall knockout plate on luminaire.



Step 4: If using threaded rod from structure, tighten nuts on to studs until luminaire is held snugly against the ceiling.

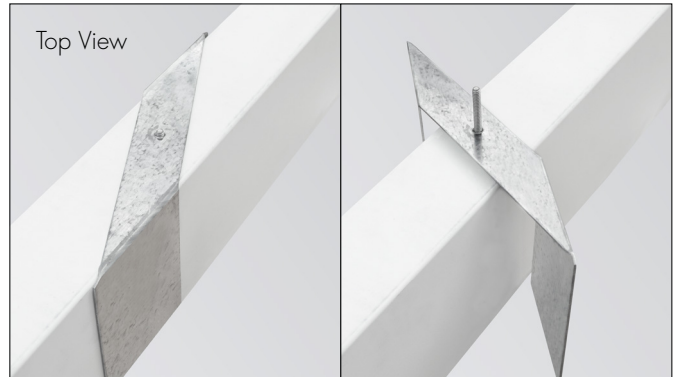

Step 4a: If using slip through brackets, place brackets against luminaire body, slip through the opening, and tighten screws. Slip through brackets will rotate and then pull against the top of the drywall until luminaire is snugly held against ceiling.

Recessed Flanged Installation

The Vector Recessed Flanged luminaire complements modern interior spaces with a sleek flange surrounding the lens of the luminaire. The recessed luminaire easily merges into concrete and drywall ceiling areas with a simple 6-step installation process.



Step 3: Remove lens and light engine from luminaire then install luminaire body in ceiling.



Step 5: Connect light engine using quick disconnects for power and dimming. Snap light engine into luminaire body.



Step 6: Insert lens into light engine to close the luminaire.

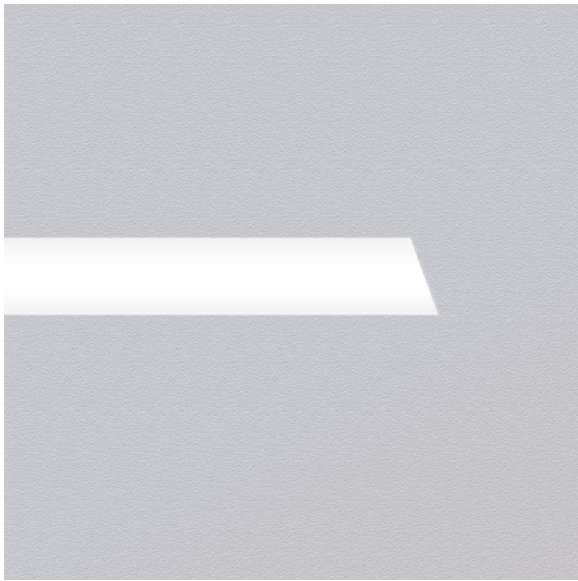

VECTOR™ Recessed Flangeless

The Vector Recessed luminaire is available in a flangeless style, ideal for modern offices and interior spaces aiming for a sleek design where the luminaires fully integrate without a visible flange protruding from the ceiling plane. This flangeless variant provides lighting designers with the flexibility to develop an interesting interior space with a variety of seamless recessed luminaires or where the ceiling design can run right up to the edges of the lighting system.

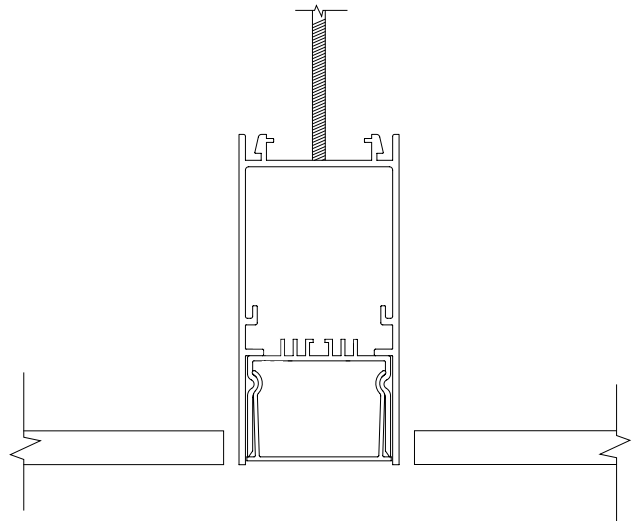





Step 1: Turn power off. Prepare opening for luminaire to be installed in.



Step 2: Connect flex cable to hole in luminaire housing.



Step 4: Fasten luminaire into ceiling. Luminaire may be fastened using threaded rod or screws into blocking above luminaire.



Step 5: Connect power and dimming wires to light engine using quick disconnects. Snap light engine into housing.



Step 3: Insert luminaire into opening.

Recessed Flangeless Installation

The Flangeless version of the Vector Recessed borrows its construction from the Surface mount variant and is equally easy to install into interior spaces. Once it is installed, the Recessed Flangeless luminaire integrates seamlessly into a hard ceiling, leaving no trace of its installation save for the light output.



Step 6: Snap lens into light engine.



Step 7: Luminaire can now be energized.

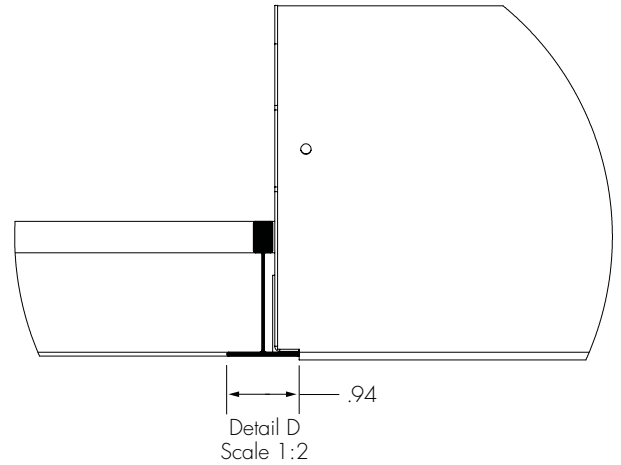
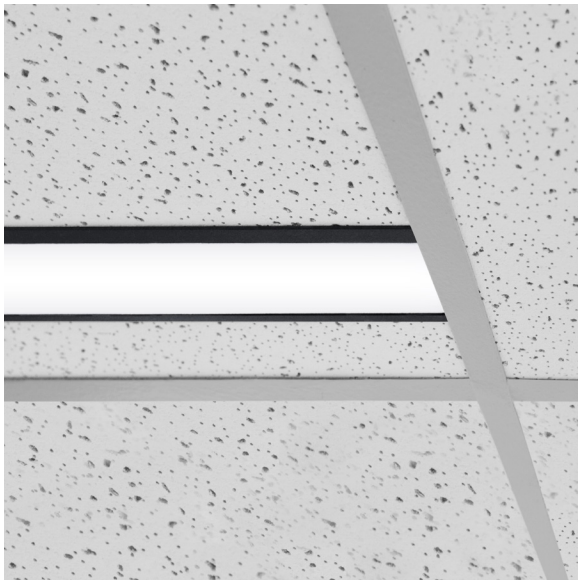

VECTOR™ Recessed T-Bar

Supported at the ends of the luminaire and with a unique T-bar bracket, the Vector Recessed T-bar can be positioned in any area along the grid, allowing for the layout of interesting, staggered patterns of fixtures. The Vector Recessed T-bar model is available in standard lengths of 2', 3', 4', 6', and 8'.

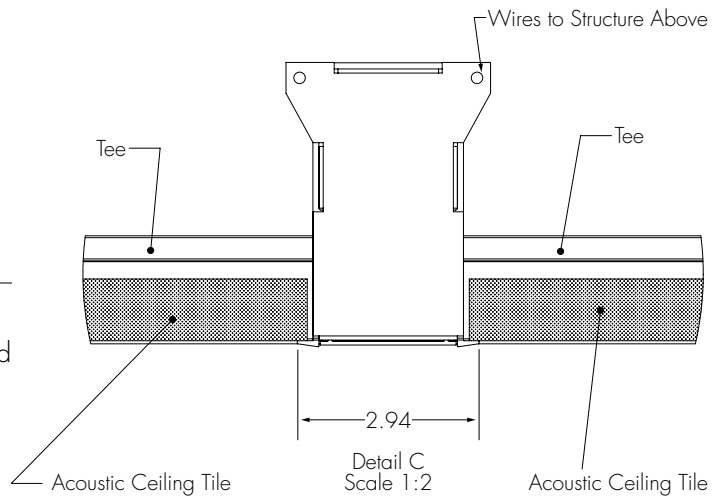



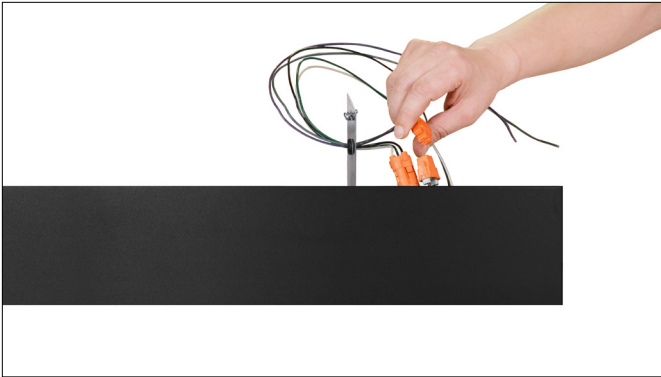

Step 1: Shut off power. Remove ceiling tile from desired Vector location. Remove Vector knockout plate. Remove pigtail.

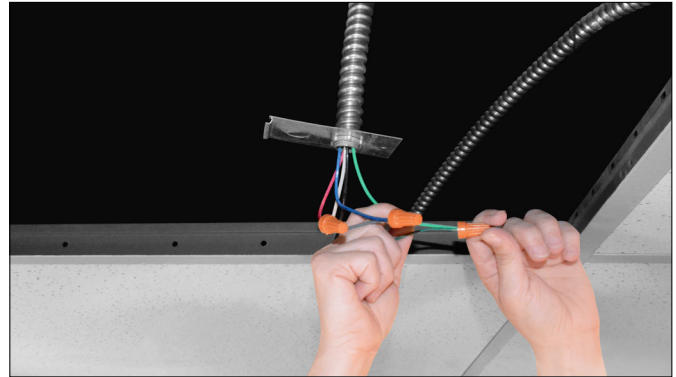

Step 2: Mount knockout plate to flex conduit. Connect pigtail to conduit wires.



Step 3: Lay Vector luminaire in grid at desired position. Secure Vector to structure above using structural wire (by others) via holes in the Vector 2 end plates.



Step 4: Connect pigtail disconnects to luminaire disconnects. Insert wires into housing. Insert knockout plate and fasten using screw provided.

Recessed T-bar Installation

The T-bar variant of the Vector is built to easily install and integrate into standard grid ceilings in modern interior spaces. The luminaire's flange conveniently hides any imperfections in cuts to the tile, creating a clean, seamless look.



Step 5: Cut tile to fit beside luminaire and install on both sides of the luminaire.



Step 6: Power can now be turned on.



VECTOR™ Mud In Flange

The Mud in Flange variant of the Vector Recessed luminaire allows designers to provide a sleek, minimalist look for interior spaces. Blending seamlessly with walls and ceilings, the Vector Mud in Flange removes all traces of the light fixture, save for the light itself. This creates a unique presentation where uninterrupted lines of light merge directly into the modern interior space, delivering ambient illumination where the luminaires completely disappear from view.

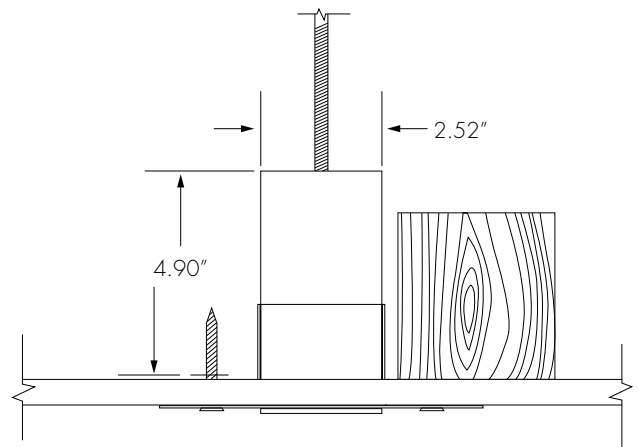

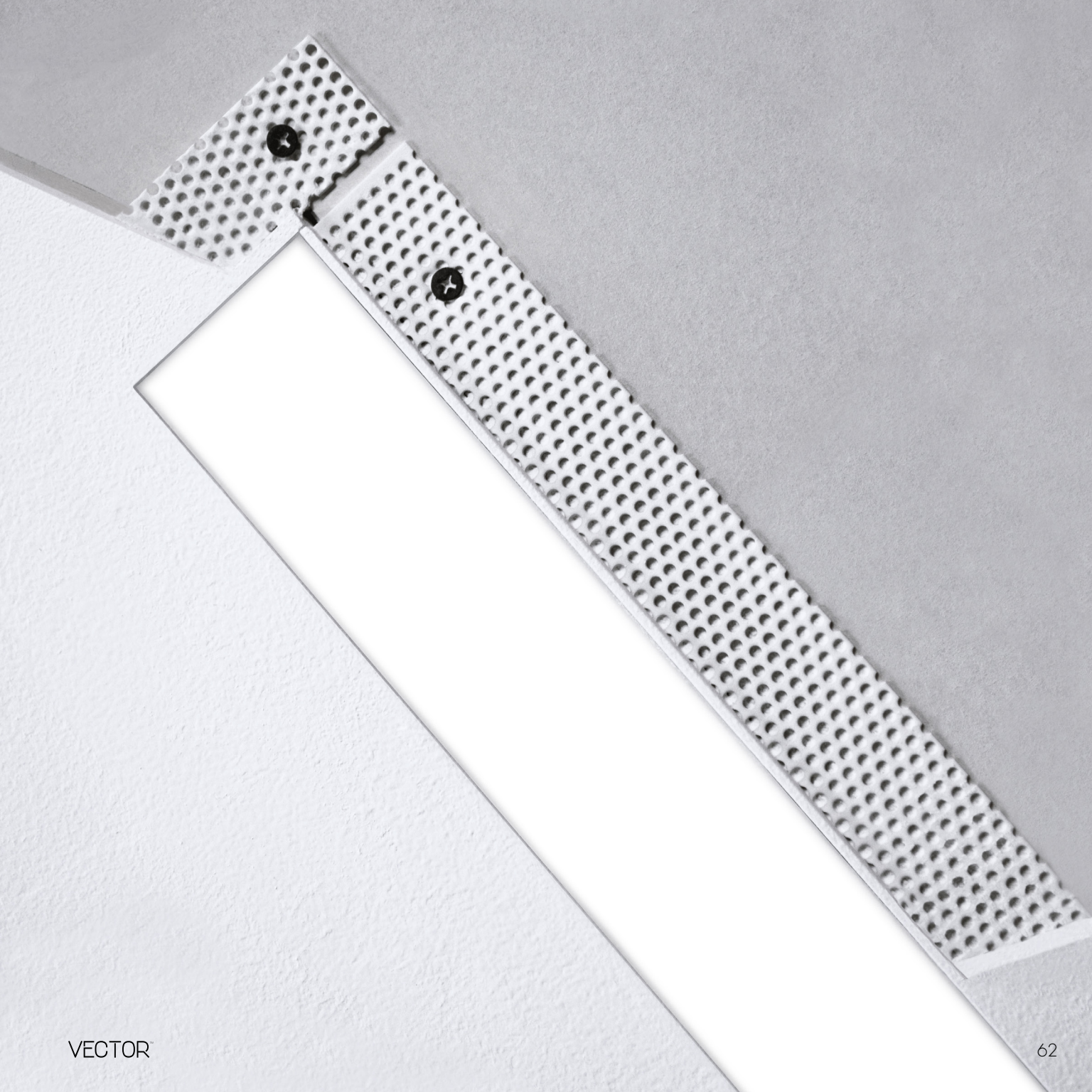



Step 1: Install luminaire into drywall, screwing through perforated flange into wood backing above drywall. Leave light engine and lens in place in luminaire. Cover flange edges with glass fiber tape.

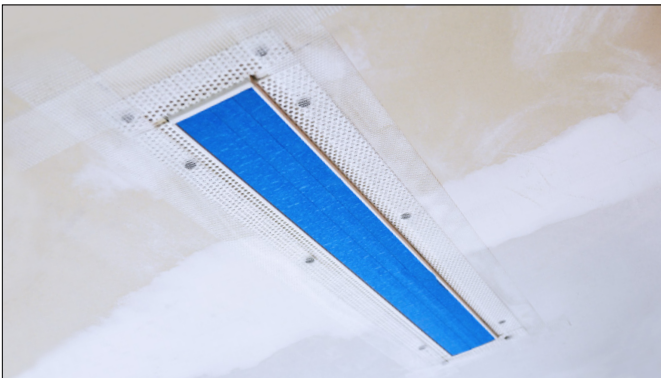

Step 2: Mask lens using painter's tape.



Step 3: Skim thin layers of plaster over flange, using 6, 8, and 12-inch plastering trowels consecutively.

Mud in Flange Installation

The hidden, perforated flange provides a practical and easy-to-install solution for creating a seamless light source in a recessed setting.

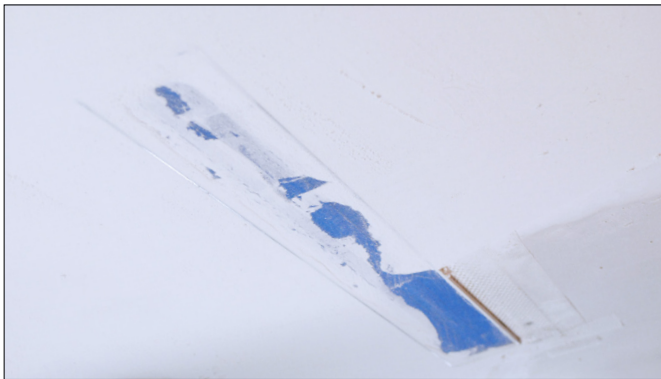

Step 4: Clean excess plaster off of tape and paint.

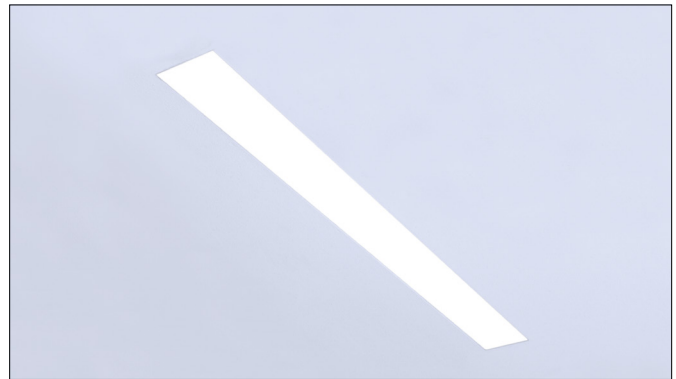

Step 5: Once paint is dry, remove tape. Luminaire can now be energized.



CUBE

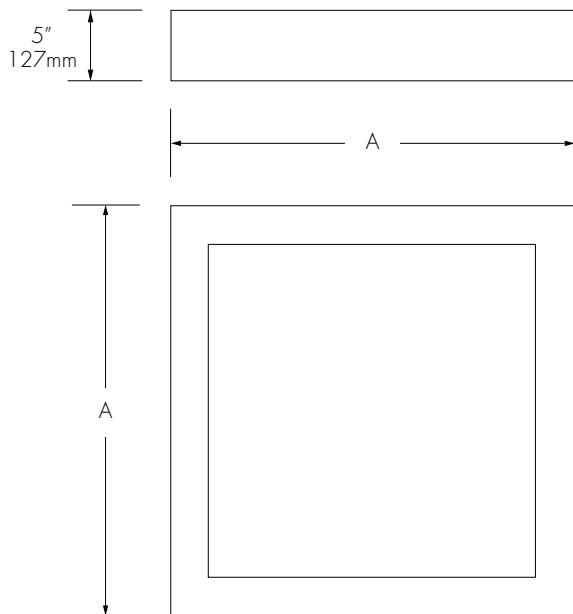

Predefined Configurations: Cube

The Vector Cube makes use of the Vector's convenient system of standardized, building-block construction to create a sleek and robust luminaire that delivers a strong impression to any interior space. Available in 2, 3, and 4-foot lengths standard, the Vector Cube can be ordered in Vector 1, Vector 2, or Vector 3 aperture sizes by default. However, there are also limitless sizes and variations of the Vector Cube that can be created with the Vector series of luminaires and joiner accessories.

	2 ft	3 ft	4 ft
A	26.2" 665.48 mm	38.2" 970.28 mm	50.2" 1275.08 mm

Dimensions provided are for Vector 2 only. Please consult with Deco for Vector 1 & 3.



HEX

Predefined Configurations: Hex

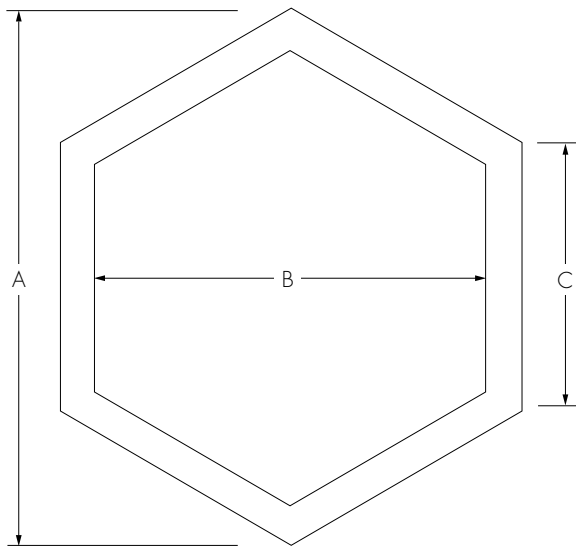

The Vector is available in a variety of standard shapes, including the Hex variant. The Vector Hex is available in three standard sizes and is designed with a limitless number of potential layouts in mind. One potential configuration is the honeycomb layout, in which several Vector Hex luminaires are mounted side-by-side, creating a unique, seemingly-infinite luminaire design.

	4 ft	6 ft	8 ft
A	50.34" 1278.636 mm	74.34" 1888.236 mm	98.34" 2497.836 mm
B	43.16" 1096.264 mm	64.4" 1635.76 mm	85.12" 2164.08 mm
C	25.17" 639.318 mm	37.17" 944.118 mm	49.17" 1248.918 mm

Dimensions provided are for Vector 2 only. Please consult with Deco for Vector 1 & 3.

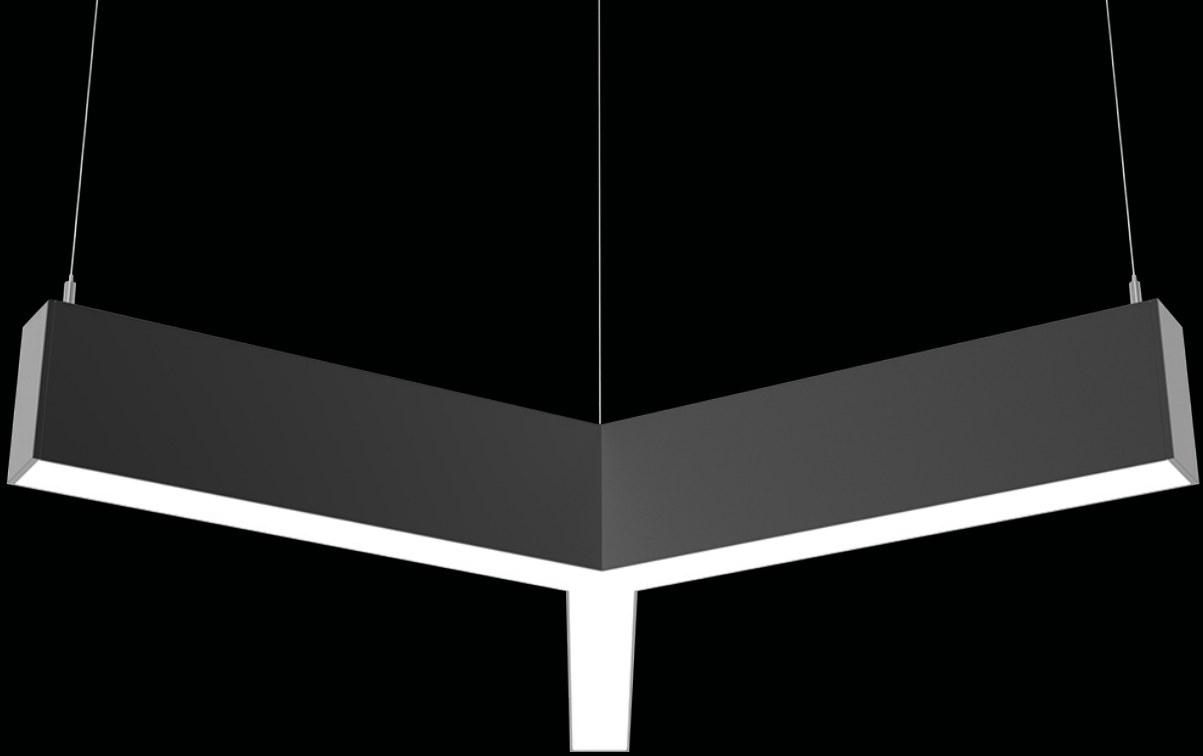

TRIAD

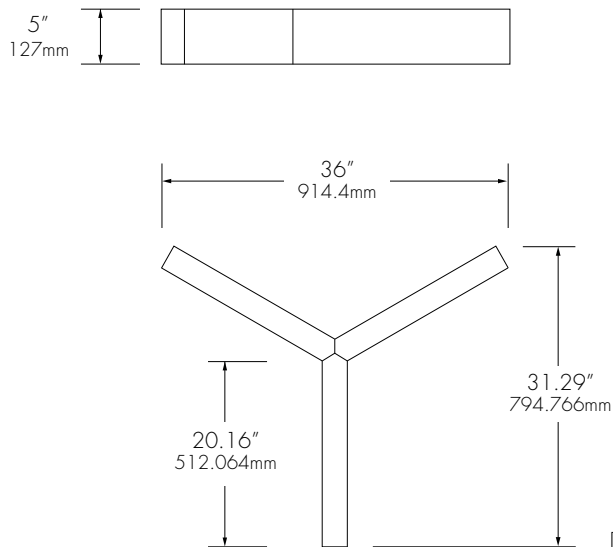

Predefined Configurations: Triad

The Vector Triad luminaire combines striking, bold design with top-quality illumination standard as part of the Vector series of interior luminaires. Available in Vector 1, Vector 2, or Vector 3 aperture sizes, the arms of the Vector Triad luminaire can be specified in one-foot increments up to 8 feet. Delivering a triforce of design, performance, and robust construction, the Vector Triad aims to elevate the look of modern interior spaces with a forward-thinking and unique aesthetic.

Dimensions provided are for Vector 2 only. Please consult with Deco for Vector 1 & 3.



Photometrics

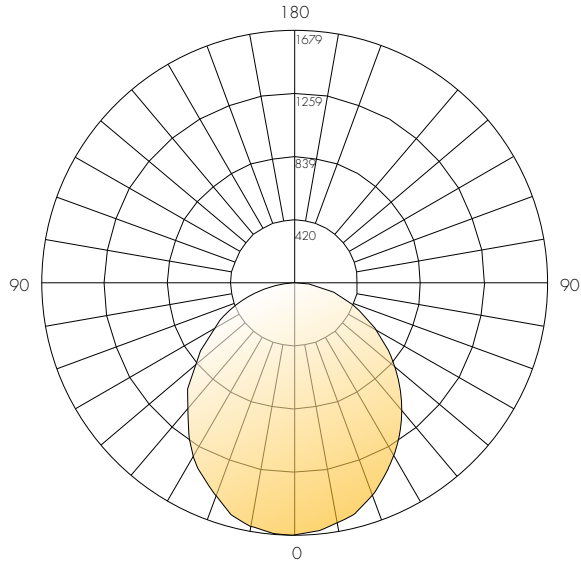

Polar Graph - Candela Tabulation Direct

vertical angle	horizontal angle		
AG	0	45	90
0	1675.80	1675.80	1670.80
5	1665.15	1660.10	1670.35
15	1580.10	1580.40	1600.50
25	1430.65	1430.80	1450.40
35	1230.60	1240.60	1270.10
45	1000.20	1015.50	1040.20
55	760.40	770.70	800.90
65	520.40	530.80	540.00
75	280.20	290.80	290.20
85	80.40	80.20	80.30
90	0.00	0.00	0.00

V2X-D-4-H-35-U-IES

Max. Candela = 1678.977 / Horizontal Angle: 90 / Vertical Angle: 2.5
Efficacy Rating: 90 / Total Watts: 49.17

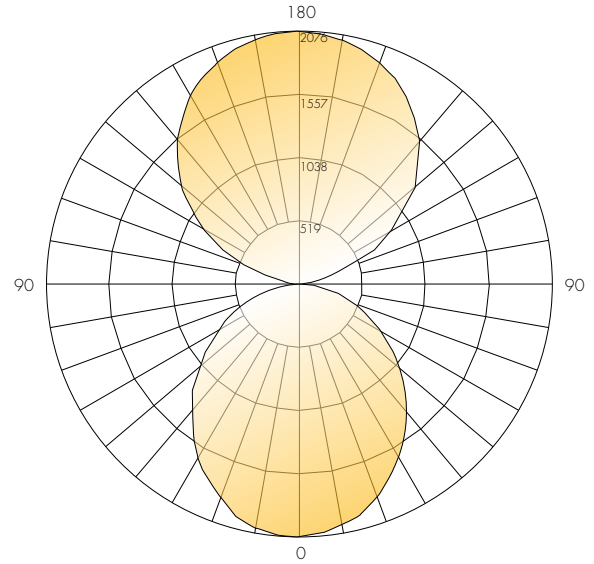

Polar Graph - Candela Tabulation Direct / In-Direct

vertical angle	horizontal angle		
AG	0	45	90
0	1600.20	1600.20	1600.20
5	1600.60	1590.10	1610.00
15	1530.30	1520.20	1530.70
25	1390.50	1380.70	1390.20
35	1200.75	1195.80	1210.60
45	980.00	980.30	990.00
55	750.40	750.25	750.70
65	520.70	510.00	510.70
75	290.85	280.40	270.90
85	100.80	90.40	70.40
90	0.00	0.00	0.00

V2X-I-4-HH-35-35-U-IES

Max. Candela = 2076.465 / Horizontal Angle: 90 / Vertical Angle: 177.5
Efficacy Rating: 97 / Total Watts: 101.6

Lumen Adjustment Factors - 90 CRI

3000K	3500K	4000K
0.974	1	1.026

Apply a lumen adjustment factor to calculate lumens for the desired CCT and CRI.



Lumen Chart

The Vector's form and sturdy construction are paired with the ability to deliver light that provides both quality illumination and energy-efficient performance. Incorporating top quality lighting components, the Vector is truly a modern luminaire that provides flexibility in how a space is illuminated, featuring three output levels and independently-selectable direct/indirect output.

Lumen values shown are for 4000K models.
For other color temperatures, use the below multipliers:
2700K: 0.85, 3000K: 0.90, 3500K: 0.95

Direct

output selection	low	medium	high
normal wattage	7.5w/ft	10w/ft	15w/ft
lumens per foot	570	855	1160
2' length			
system wattage	12.00	18.00	24.00
lumen output	1140	1700	2320
3' length			
system wattage	18.00	27.00	36.00
lumen output	1710	2550	3480
4' length			
system wattage	24.00	36.00	49.00
lumen output	2280	3400	4640
6' length			
system wattage	36.00	54.00	72.00
lumen output	3420	5100	6960
8' length			
system wattage	48.00	72.00	96.00
lumen output	4560	6800	9280

In-Direct

output selection	low	medium	high
normal wattage	7.5w/ft	10w/ft	15w/ft
lumens per foot	720	1080	1440
2' length			
system wattage	12.00	18.00	24.00
lumen output	1440	2160	2880
3' length			
system wattage	18.00	27.00	36.00
lumen output	2160	3240	4320
4' length			
system wattage	24.00	36.00	48.00
lumen output	2880	4320	5760
6' length			
system wattage	36.00	54.00	72.00
lumen output	4320	6480	8640
8' length			
system wattage	48.00	72.00	96.00
lumen output	5760	8640	11520

Quickship Models

Quickship orders will ship within 5-10 business days from the receipt of a purchase order, Monday - Friday, not including Holidays. Order must be placed before 12:00 PM (PST) for the 24 hours to begin that day. Orders placed after 12:00 PM will be processed the following business day.

Quickship orders must be placed separately and cannot include products outside the Quickship product list.

Orders sent to orders@getdeco.com must reference "Quickship," not including this may result in delays of the order, and will be scheduled with the standard product lead time.

Standard product warranty applies to all Quickship products.



Styles	Length	Output	CCT	Finish	Run Guide
V2P Vector 2 Pendant*	2 2'	L 7.5W / ft	30 3000K	W Textured White	A First
V2S Vector 2 Surface	3 3'	M 10W / ft	35 3500K	B Textured Black	B Middle
V2R Vector 2 Recessed	4 4'	H 15W / ft	40 4000K		C End
	6 6'				
	8 8'				

*Only available in direct/indirect distribution for Pendant style

Note that for Direct/Indirect models the outputs must match (Ex, M+M)

DLC Listed Models

Select 4' and 8' direct/indirect pendant models listed for utility rebates

4'

3500K

Mid Output: V2P-I-4-M-M-35-35-U

High Output: V2P-I-4-H-H-35-35-U

4000K

Mid Output: V2P-I-4-M-M-40-40-U

8'

3500K

Mid Output: V2P-I-8-M-M-35-35-U

High Output: V2P-I-8-H-H-35-35-U

4000K

Mid Output: V2P-I-8-M-M-40-40-U

High Output: V2P-I-8-H-H-40-40-U



DLC logo only applies to V2P quickship model numbers noted here. Other models may not be DLC-listed in all possible configurations and DLC-listed part numbers may not exactly match internal DECO quickship part numbers. Please consult factory for DLC cross reference part numbers and always verify the full list of DLC Qualified Products at: <https://www.designlights.org/search/>

Continuous Runs

Continuous runs of the Vector can also be ordered through the Quickship program. Please consult the Continuous Run Guide on our website to determine the individual lengths needed.

For instance:

A 24' run would consist of an 8' first of run, an 8' middle of run, and an 8' end of run. These sections are indicated by a letter at the end of each order code:

A=First, **B**=Middle, and **C**=End.

A configurator for continuous runs will soon be available online.

Example: Submittal Drawing 13' Continuous Run - Pendant

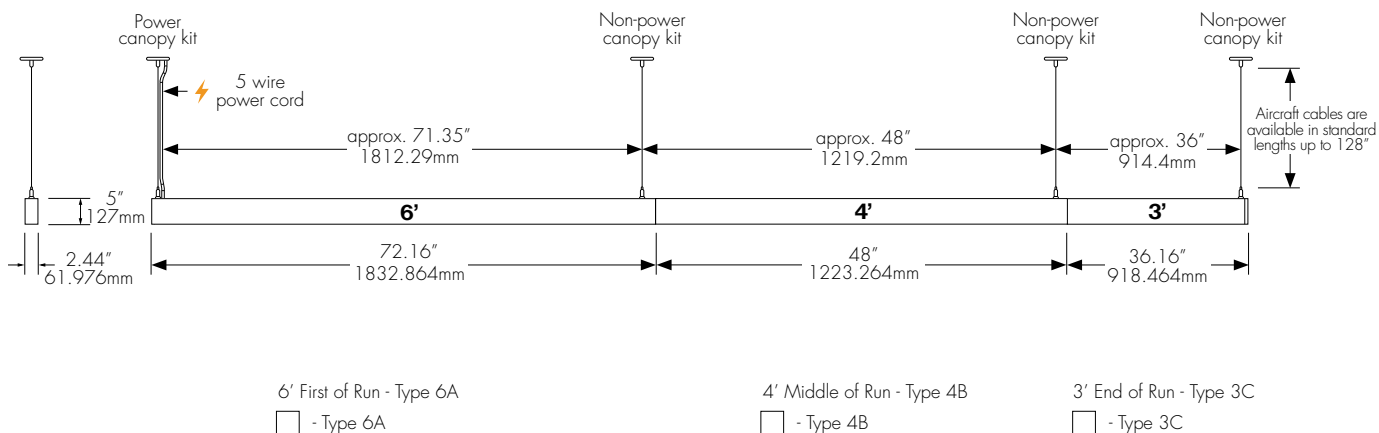

Ordering Information

A Pendant

V1P Vector 1
Pendant

V2P Vector 2
Pendant

V3P Vector 3
Pendant

V1P **I** **2** **L** **L** **27** **27** **U** **CA** **W** **DC**
A B C D E F G H I J L
example

A Wall Mount

V1W Vector 1
Wall Mount

V2W Vector 2
Wall Mount

V3W Vector 3
Wall Mount

V1W **D** **3** **M** **M** **30** **30** **U** **B** **T**
A B C D E F G H J L
example

A Surface Mount

V1S Vector 1
Surface Mount

V2S Vector 2
Surface Mount

V3S Vector 3
Surface Mount

V2S **4** **M** **35** **U** **W** **U**
A C D F H J L
example

A Recessed Hard Ceiling

V2R Vector 2 Recessed
Hard Ceiling

V2R **6** **H** **40** **U** **B** **V**
A C D F H J L
example

B Distribution

I	Direct/Indirect
D	Direct

C Length

2	2'
3	3'
4	4'
6	6'
8	8'
Sxxx	System ¹

D Output Down

L	7.5W / ft
M	10W / ft
H	15W / ft

E Output Up*

L	7.5W / ft
M	10W / ft
H	15W / ft

F CCT Down

27	2700K
30	3000K
35	3500K
40	4000K
5W	5 Channel Color Tuning ²

G CCT Up*

27	2700K
30	3000K
35	3500K
40	4000K
5W	5 Channel Color Tuning ²

H Voltage

U	120-277V
---	----------

I Mounting Cable

CA	24" Cable
CB	48" Cable
CD	60" Cable
CF	72" Cable
CG	96" Cable
CH	120" Cable
CJ	150" Cable
CK	180" Cable
CL	240" Cable

J Finish⁵

W	Textured White
S	Textured Silver
B	Textured Black
##	Specialized Colors ^{3,4}
C	Textured Custom Colors

K Style

T1	15/16 T-Bar
T2	9/16 T-Bar
T3	Screw Slot T-Bar

L Option

DC	Dual Circuit for Up/Down*
E	Emergency
T	Daylight Sensor
U	Occupancy Sensor
V	Daylight/Occupancy Sensor
VWO	Lutron Vive System Enabled Fixture(External RF only) Standard 0-10V X% Driver

VWOSO	Lutron Vive Wireless Fixture (External RF w/Occ and Daylight Sensor) Standard DALI X% Driver
VVD	Lutron Vive System Enabled Fixture (Integral RF only) Standard DALI X% Driver
VWSD	Lutron Vive Wireless Fixture (Integral RF w/Occ and Daylight Sensor) Standard DALI X% Driver
ES1	Lutron LDE1 Series EcoSystem 1% Dimming with Soft On Fade to Black
ES5	Lutron LDE5 Series EcoSystem 5% Dimming

*Only available when direct/indirect distribution is selected.

¹Replace "xxx" with desired system length, in feet. See Continuous Run Guide for additional information (separate document).

²5 Channel color tuning only available at high output setting.

³See Custom Color Options page for ordering codes on specialized finishes (example = "07").

⁴Please Note: All orders under 25 linear feet will require a one-time set up charge. Please consult factory for charge.

⁵All finishes are textured unless specified otherwise by the customer.

Ordering Information

A Recessed T-Bar

V2T Vector 2
Recessed T-Bar

V2T **6** **H** **5W** **U** **S** **T1** **VWD**

A **C** **D** **F** **H** **J** **K** **L**

example

A Mud-In-Flange

V1M Vector 1
Mud-in-Flange

V2M Vector 2
Mud-in-Flange

V3M Vector 3
Mud-in-Flange

V3M **8** **H** **5W** **U** **C** **ES5**

A **C** **D** **F** **H** **J** **L**

example

B Distribution

I	Direct/Indirect
D	Direct

C Length

2	2'
3	3'
4	4'
6	6'
8	8'
Sxxx	System ¹

D Output Down

L	7.5W / ft
M	10W / ft
H	15W / ft

E Output Up*

L	7.5W / ft
M	10W / ft
H	15W / ft

F CCT Down

27	2700K
30	3000K
35	3500K
40	4000K
5W	5 Channel Color Tuning ²

G CCT Up*

27	2700K
30	3000K
35	3500K
40	4000K
5W	5 Channel Color Tuning ²

H Voltage

U	120-277V
---	----------

I Mounting Cable

CA	24" Cable
CB	48" Cable
CD	60" Cable
CF	72" Cable
CG	96" Cable
CH	120" Cable
CJ	150" Cable
CK	180" Cable
CL	240" Cable

J Finish⁵

W	Textured White
S	Textured Silver
B	Textured Black
##	Specialized Colors ^{3,4}
C	Textured Custom Colors

K Style

T1	15/16 T-Bar
T2	9/16 T-Bar
T3	Screw Slot T-Bar

L Option

DC	Dual Circuit for Up/Down*
E	Emergency
T	Daylight Sensor
U	Occupancy Sensor
V	Daylight/Occupancy Sensor
VWO	Lutron Vive System Enabled Fixture(External RF only) Standard 0-10V X% Driver

VWOSO	Lutron Vive Wireless Fixture (External RF w/Occ and Daylight Sensor) Standard DALI X% Driver
VWD	Lutron Vive System Enabled Fixture (Integral RF only) Standard DALI X% Driver
VWSD	Lutron Vive Wireless Fixture (Integral RF w/Occ and Daylight Sensor) Standard DALI X% Driver
ES1	Lutron LDE1 Series EcoSystem 1% Dimming with Soft On Fade to Black
ES5	Lutron LDE5 Series EcoSystem 5% Dimming

*Only available when direct/indirect distribution is selected.

¹Replace "xxx" with desired system length, in feet. See Continuous Run Guide for additional information (separate document).

²5 Channel color tuning only available at high output setting.

³See Custom Color Options page for ordering codes on specialized finishes (example = "07").

⁴Please Note: All orders under 25 linear feet will require a one-time set up charge. Please consult factory for charge.

⁵All finishes are textured unless specified otherwise by the customer.

A Cube Pendant

CU2P	Cube 2 Pendant	CU2P	I	2	2	L	L	27	27	U	C	CA	W	E
		A	B	C	D	E	F	G	H	I	J	K	L	M
	example													

A Cube Recessed

CU2R	Cube 2 Recessed	CU2R	3	3	M	30	U	S	VWD
		A	C	D	E	G	I	L	M
	example								

A Cube Surface

CU2S	Cube 2 Surface	CU2S	4	4	H	5W	U	B	ES1
		A	C	D	E	G	I	L	M
	example								

A Hex Pendant

HX2P	Hex 2 Pendant	HX2P	I	4	L	L	30	30	U	M	A	S	T
		A	B	D	E	F	G	H	I	J	K	L	M
	example												

A Hex Recessed

HX2R	Hex 2 Recessed	HX2R	5	H	40	U	B	V
		A	D	E	G	I	L	M
	example							

A Hex Surface

HX2S	Hex 2 Surface	HX2S	7	M	5W	U	S	ES1
		A	D	E	G	I	L	M
	example							

A Triad Pendant

TR2P	Triad 2 Pendant	TR2P	I	2	L	L	27	27	U	C	D	B	ES5
		A	B	C	E	F	G	H	I	J	K	L	M
	example												

A Triad Recessed

TR2R	Triad 2 Recessed	TR2R	3	M	40	U	B	VWO
		A	D	E	G	I	L	M
	example							

A Triad Surface

TR2S	Triad 2 Surface	TR2S	4	H	27	U	B	U
		A	D	E	G	I	L	M
	example							

Legend

B Distribution

I	Direct/Indirect
D	Direct

C Length

2	2'
3	3'
4	4'

D Width

2	2'
3	3'
4	4'
5	5'
7	7'

E Output Down

L	7.5W / ft
M	10W / ft
H	15W / ft

F Output Up*

L	7.5W / ft
M	10W / ft
H	15W / ft

G CCT Down

27	2700K
30	3000K
35	3500K
40	4000K
5W	5 Channel Color Tuning ²

H CCT Up*

27	2700K
30	3000K
35	3500K
40	4000K
5W	5 Channel Color Tuning ²

I Voltage

U	120-277V
---	----------

J Mounting Style

C	Cable in Corner
M	Monopoint

K Cable Length

A	24" Cable
B	48" Cable
D	60" Cable
F	72" Cable
G	96" Cable

L Finish⁵

W	Textured White
S	Textured Silver
B	Textured Black
##	Specialized Colors ^{3,4}
C	Textured Custom Colors

M Option

DC	Dual Circuit for Up/Down*
E	Emergency
T	Daylight Sensor
U	Occupancy Sensor
V	Daylight/Occupancy Sensor
VWO	Lutron Vive System Enabled Fixture(External RF only) Standard 0-10V X% Driver

VWOSO	Lutron Vive Wireless Fixture (External RF w/Occ and Daylight Sensor) Standard DALI X% Driver
VVD	Lutron Vive System Enabled Fixture (Integral RF only) Standard DALI X% Driver
VWSD	Lutron Vive Wireless Fixture (Integral RF w/Occ and Daylight Sensor) Standard DALI X% Driver
ES1	Lutron LDE1 Series EcoSystem 1% Dimming with Soft On Fade to Black
ES5	Lutron LDE5 Series EcoSystem 5% Dimming

*Only available when direct/indirect distribution is selected.

¹Replace "xxx" with desired system length, in feet. See Continuous Run Guide for additional information (separate document).

²5 Channel color tuning only available at high output setting.

³See Custom Color Options page for ordering codes on specialized finishes (example = "07").

⁴Please Note: All orders under 25 linear feet will require a one-time set up charge. Please consult factory for charge.

⁵All finishes are textured unless specified otherwise by the customer.

We've Got You Covered!

Deco Lighting provides everything you need to handle every application you encounter. Our website offers IES files, installation instructions, spec sheets, case studies and a user-friendly run guide that makes our Vector Series the simplest, smartest choice in specification-grade linear LED technology. Our Applications Team stands ready to provide lighting layouts and point-by-points at your request. The Vector Series has been independently tested by certified laboratories in accordance with LM-79-08 procedures and it is the only high-end linear product of its kind that qualifies for DLC at 100 LPW, an R9 value greater than 69, and a minimum CRI rating of 95. If you have any questions or comments regarding the Vector Series please contact us at info@getdeco.com



LEGAL NOTES:

Information in this catalog was valid at this time of printing, is non-binding, and should be used for information purposes only. We are not liable for products that differ from illustration or information. Deco Lighting practices a program of continuous product development, and as a result product specifications change frequently. We reserve the right to change product specifications without notice. Contact Deco for the latest product information or visit www.getdeco.com

DECO® | **LIGHTING**

2917 Vail Ave. Commerce, CA 90040

T: 800-613-3326 • 310-366-6866

F: 310-366-6855

info@getdeco.com

www.getdeco.com

© Copyright 2018 Deco Enterprises, Inc. All rights reserved.



DECO® | LIGHTING

2917 Vail Ave. Commerce, CA 90040

T: 800-613-3326 • 310-366-6866

F: 310-366-6855

info@getdeco.com

www.getdeco.com

© Copyright 2018 Deco Enterprises, Inc. All rights reserved.

